

Unit: mm

MUZ-HR25VF MUZ-HR35VF
OUTDOOR UNIT

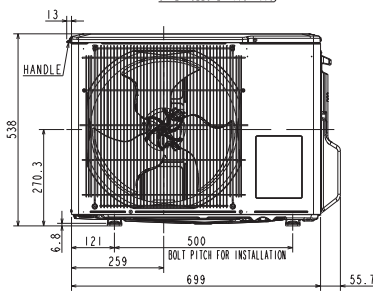

REQUIRED SPACE

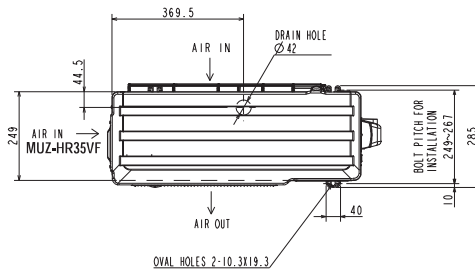
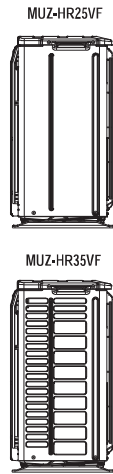
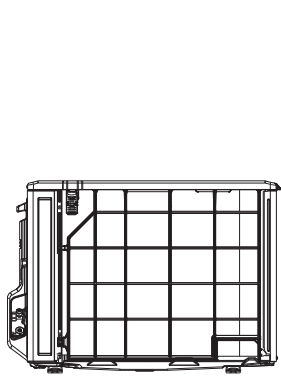
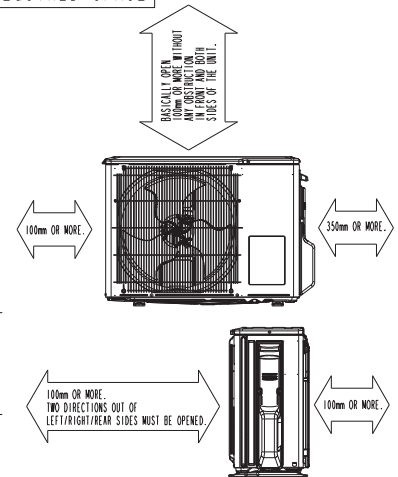

REFRIGERANT PIPE JOINT	LIQUID REFRIGERANT PIPE	FLARED 6.35(1/4")
	GAS REFRIGERANT PIPE	FLARED 9.52(3/8")

MUZ-HR42VF MUZ-HR50VF
OUTDOOR UNIT

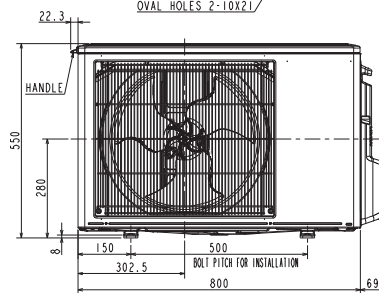
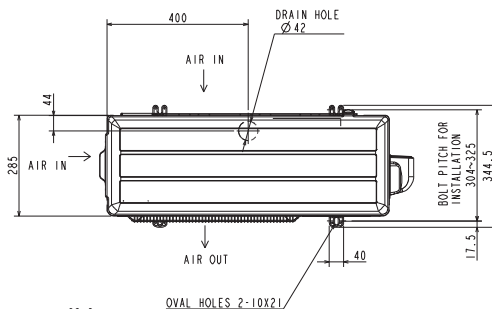
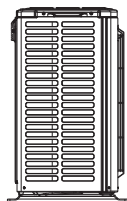
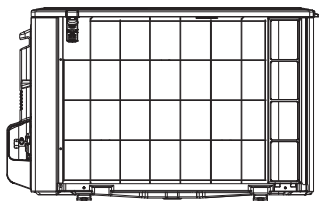

REQUIRED SPACE

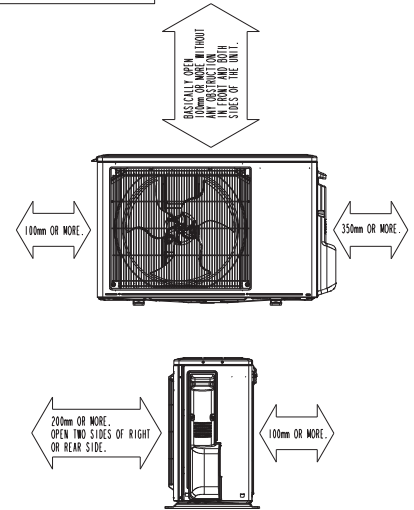

REFRIGERANT PIPE JOINT	LIQUID REFRIGERANT PIPE	FLARED 6.35(1/4")
	GAS REFRIGERANT PIPE	FLARED 9.52(3/8")

OUTLINES AND DIMENSIONS

WALL-MOUNTED