

Revision C:

- Error Code has been added in 10-4. TROUBLESHOOTING CHECK TABLE.

OBH816 REVISED EDITION-B is void.

INDOOR UNIT SERVICE MANUAL

**No. OBH816
REVISED EDITION-C**

Models

MSY-TP35VF - E1, ET1, ER1, E2

MSY-TP50VF - E1, ET1, ER1, E2

Outdoor unit service manual
MUY-TP-VF Series (OBH817)

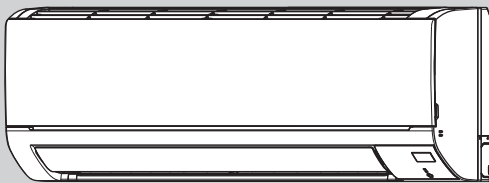

CONTENTS

1. TECHNICAL CHANGES	3
2. PART NAMES AND FUNCTIONS	4
3. SPECIFICATION	5
4. NOISE CRITERIA CURVES	6
5. OUTLINES AND DIMENSIONS	7
6. WIRING DIAGRAM	8
7. REFRIGERANT SYSTEM DIAGRAM	10
8. SERVICE FUNCTIONS	11
9. MICROPROCESSOR CONTROL	13
10. TROUBLESHOOTING	22
11. DISASSEMBLY INSTRUCTIONS	33

PARTS CATALOG (OBB816)

Use the specified refrigerant only

Never use any refrigerant other than that specified.

Doing so may cause a burst, an explosion, or fire when the unit is being used, serviced, or disposed of.

Correct refrigerant is specified in the manuals and on the spec labels provided with our products.

We will not be held responsible for mechanical failure, system malfunction, unit breakdown or accidents caused by failure to follow the instructions.

<Preparation before the repair service>

- Prepare the proper tools.
- Prepare the proper protectors.
- Provide adequate ventilation.
- After stopping the operation of the air conditioner, turn off the power-supply breaker and pull the power plug.
- Discharge the capacitor before the work involving the electric parts.

<Precautions during the repair service>

- Do not perform the work involving the electric parts with wet hands.
- Do not pour water into the electric parts.
- Do not touch the refrigerant.
- Do not touch the hot or cold areas in the refrigeration cycle.
- When the repair or the inspection of the circuit needs to be done without turning off the power, exercise great caution not to touch the live parts.

WARNING

- When the refrigeration circuit has a leak, do not execute pump down with the compressor.
- When pumping down the refrigerant, stop the compressor before disconnecting the refrigerant pipes. The compressor may burst if air etc. get into it.
- When opening or closing the valve below freezing temperatures, refrigerant may spurt out from the gap between the valve stem and the valve body, resulting in injuries.

Revision A:

- 10. TROUBLESHOOTING has been modified.

Revision B:

- MSY-TP35/50VF - ER1, E2 have been added.

Revision C:

- Error Code has been added in 10-4. TROUBLESHOOTING CHECK TABLE.

1

TECHNICAL CHANGES

MSY-TP35VF -**E1**, **ET1**, **ER1**

MSY-TP50VF -**E1**, **ET1**, **ER1**

1. New model

MSY-TP35VF -**E1** → **MSY-TP35VF** -**E2**

MSY-TP50VF -**E1** → **MSY-TP50VF** -**E2**

1. Indoor electronic control P.C.board has been changed.

2

PART NAMES AND FUNCTIONS

MSY-TP35VF MSY-TP50VF

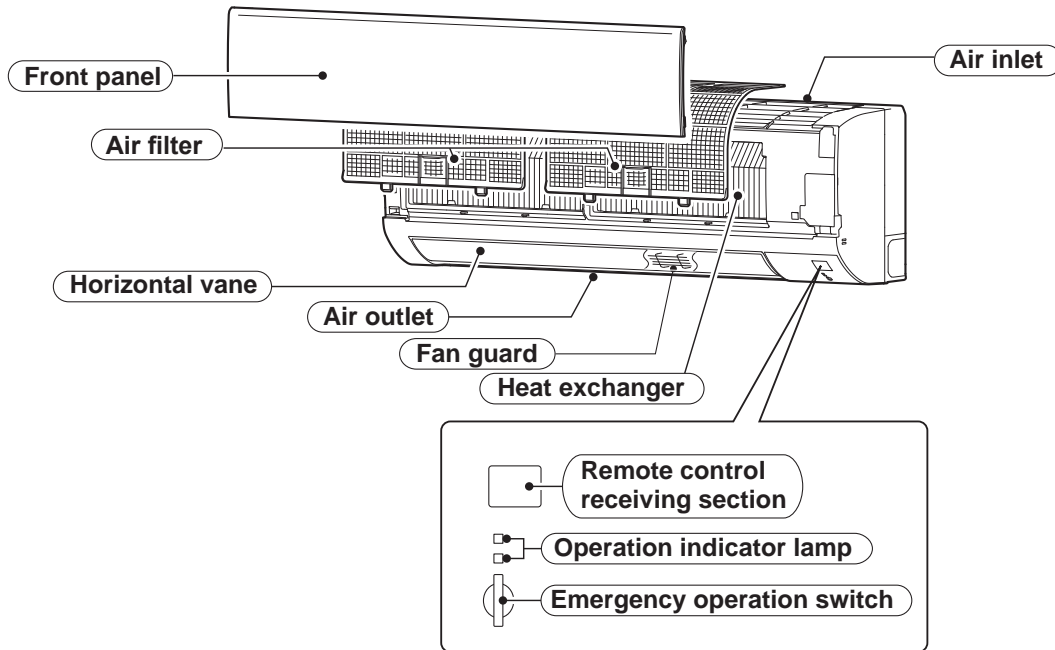

ACCESSORIES

①	Installation plate	1
②	Installation plate fixing screw 4 × 25 mm	5
③	Felt tape (Used for left or left-rear piping)	1

3

SPECIFICATION

Indoor model				MSY-TP35VF	MSY-TP50VF	
Power supply				Single phase 230 V, 50 Hz		
Breaker Capacity			A	10		
Electrical data	Power input *1 (Total)	Cooling	W	760	1,450	
	Running current *1 (Total)	Cooling	A	3.6	6.4	
	Power factor *1 (Total)	Cooling	%	91	98	
	Starting current *1 (Total)		A	3.6	6.4	
Fan motor	Model			[E1], [ET1]: RC0J30-MD, [ER1], [E2]: RCOJ40-SA		
	Current *1	Cooling	A	0.32		
Dimensions W x H x D			mm	923 x 305 x 250		
Weight			kg	12.5		
Special remarks	Air direction			5		
	Airflow	Cooling	Super High	m³/h	984	990
			High		822	
			Med.		696	
			Low		606	
	Sound level	Cooling	Super High	dB(A)	45	
			High		40	
			Med.		36	
			Low		31	
	Fan speed	Cooling	Super High	rpm	1,070	1,080
			High		930	
			Med.		820	
			Low		740	
Fan speed regulator				4		

NOTE : Test conditions are based on ISO 5151.

Cooling : Indoor Dry-bulb temperature 27°C

Wet-bulb temperature 19°C

Outdoor Dry-bulb temperature 35°C

*1 Measured under rated operating frequency.

Specifications and rated conditions of main electric parts

Fuse	(F11)	T3.15AL250V
Horizontal vane motor	(MV)	12 V DC
Varistor	(NR11)	470 V
Terminal block	(TB)	5P

MSY-TP35VF

MSY-TP50VF

FAN SPEED	FUNCTION	SPL(dB(A))	LINE
Super High	COOLING	45	●—●

FAN SPEED	FUNCTION	SPL(dB(A))	LINE
Super High	COOLING	45	●—●

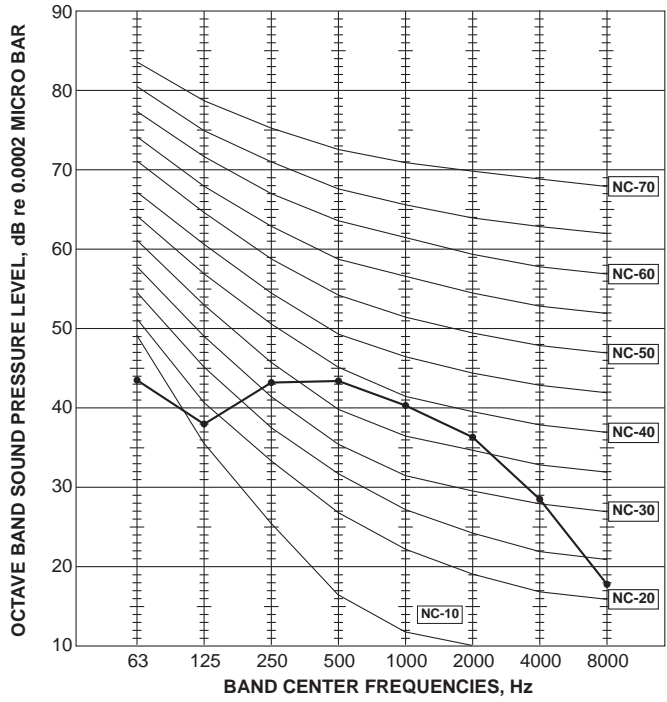
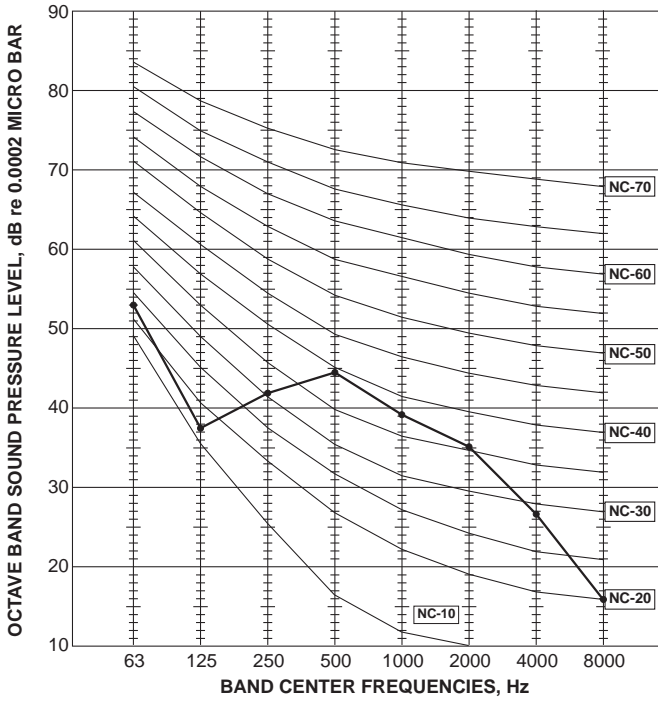

Test conditions

Cooling : Dry-bulb temperature 27°C Wet-bulb temperature 19°C

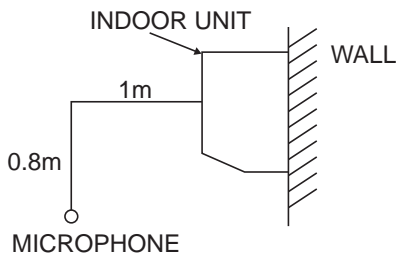

5

OUTLINES AND DIMENSIONS

MSY-TP35VF MSY-TP50VF

Unit: mm

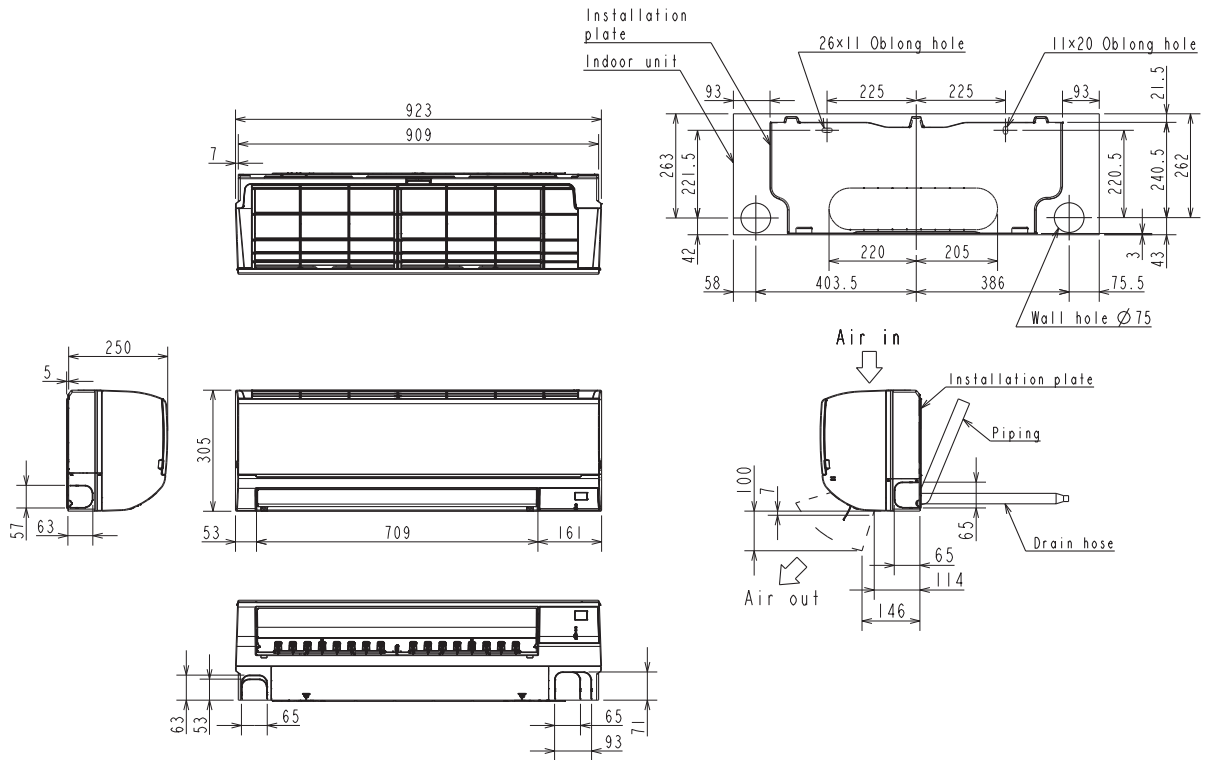

Piping	Insulation	Ø50 O.D
	Liquid line	Ø8 - 0.5m (Flared connection Ø6.35)
	Gas line	Ø12 - 0.45m (Flared connection Ø9.52)
	Drain hose	Insulation Connected part Ø16 O.D

MSY-TP35VF -[E1] MSY-TP50VF -[E1]

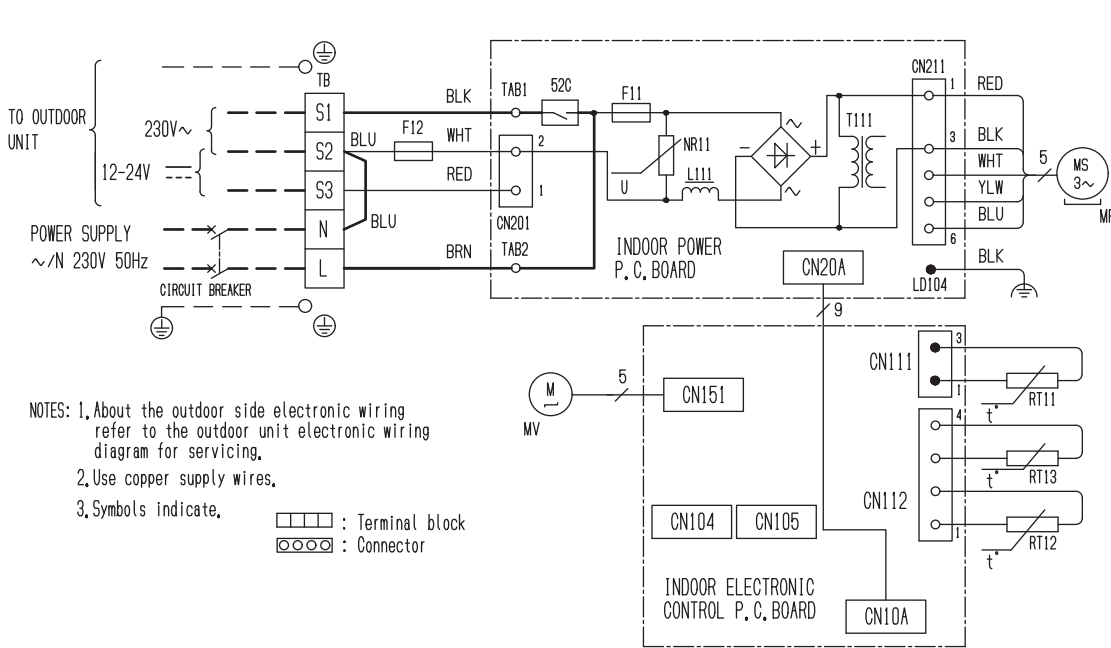

MSY-TP35VF -[ET1] MSY-TP50VF -[ET1]

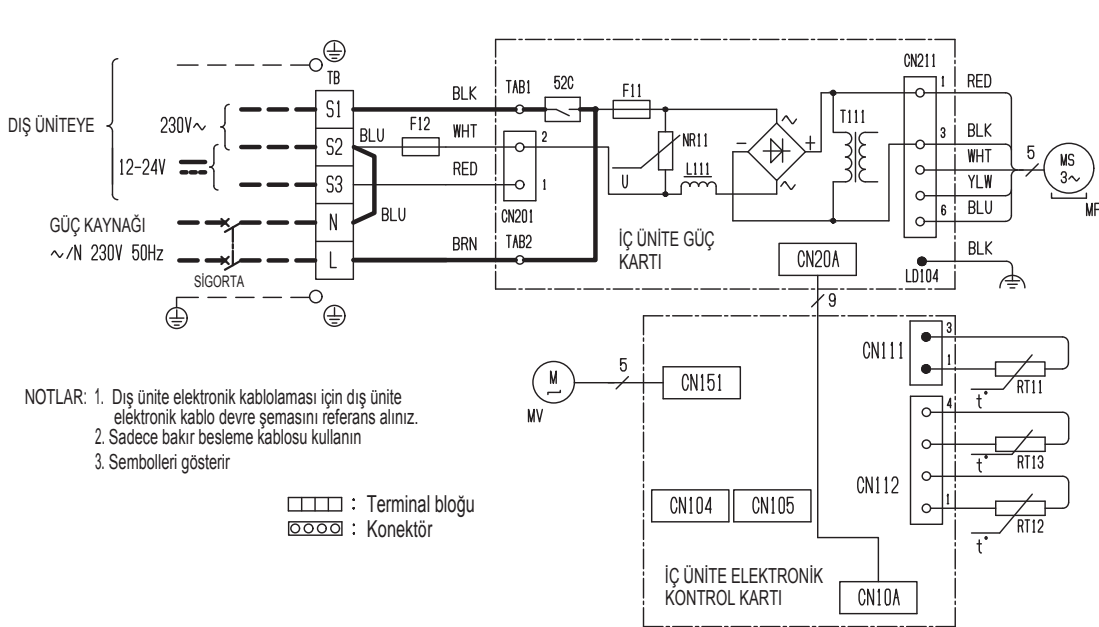

MSY-TP35VF -[E2], [ER1] MSY-TP50VF -[E2], [ER1]

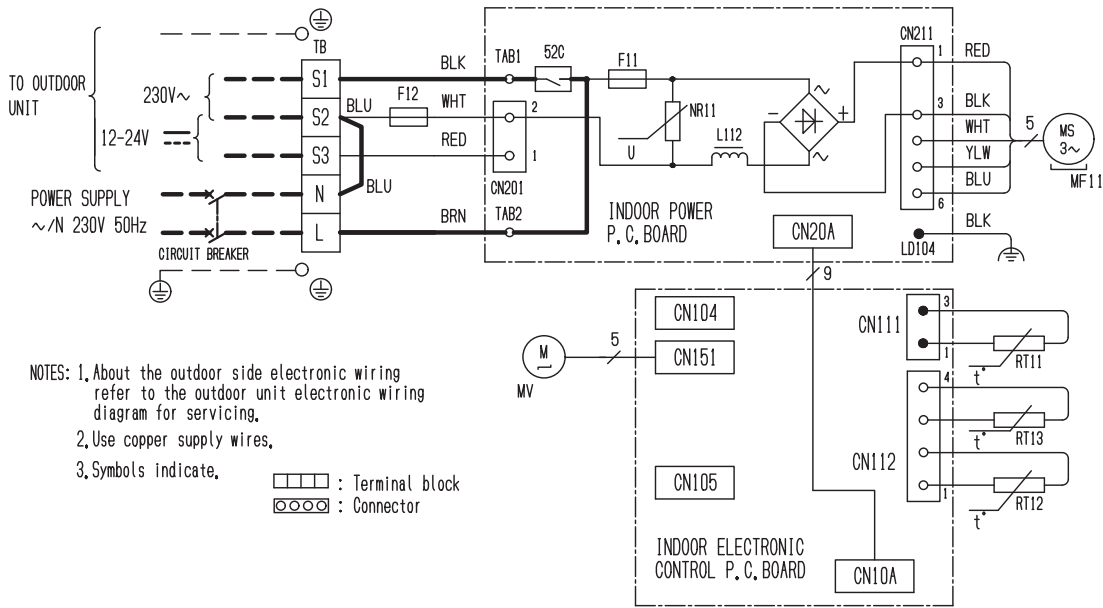

- NOTES: 1. About the outdoor side electronic wiring refer to the outdoor unit electronic wiring diagram for servicing.
 2. Use copper supply wires.
 3. Symbols indicate.

□□□□ : Terminal block
 ○○○○ : Connector

SYMBOL	NAME
F11	FUSE (T3, 15A/250V)
F12	THERMAL FUSE (102°C 4.5A)
MF11	FAN MOTOR
MV	VANE MOTOR (HORIZONTAL)
NR11	VARISTOR
L112	REACTOR
RT11	ROOM TEMP. THERMISTOR
RT12	COIL TEMP. THERMISTOR (MAIN)
RT13	COIL TEMP. THERMISTOR (SUB)
TB	TERMINAL BLOCK
TAB1, TAB2	TAB
52C	RELAY

7

REFRIGERANT SYSTEM DIAGRAM

MSY-TP35VF MSY-TP50VF

Unit: mm

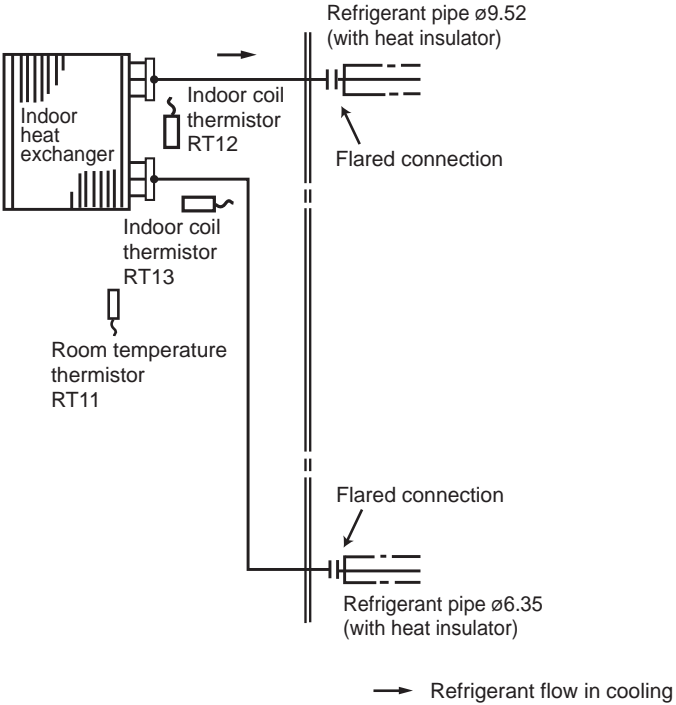

MSY-TP35VF MSY-TP50VF

8-1. TIMER SHORT MODE

For service, the following set time can be shortened by bridging the timer short mode point on the electronic control P.C. board. (Refer to 10-7.)

Set time : 3-minute → 3-second (It takes 3 minutes for the compressor to start operation. However, the starting time is shortened by bridging the timer short mode point.)

NOTE: While the relay 52C is ON, the compressor starting time cannot be shortened.

8-2. P.C. BOARD MODIFICATION FOR INDIVIDUAL OPERATION (Option: MAC-SL100M-E)

A maximum of 4 indoor units with wireless remote controllers can be used in a room.

In this case, to operate each indoor unit individually by each remote controller, P.C. boards of remote controller must be modified according to the number of the indoor unit.

How to modify the remote controller P.C. board

Remove batteries before modification.

The board has a print as shown below :

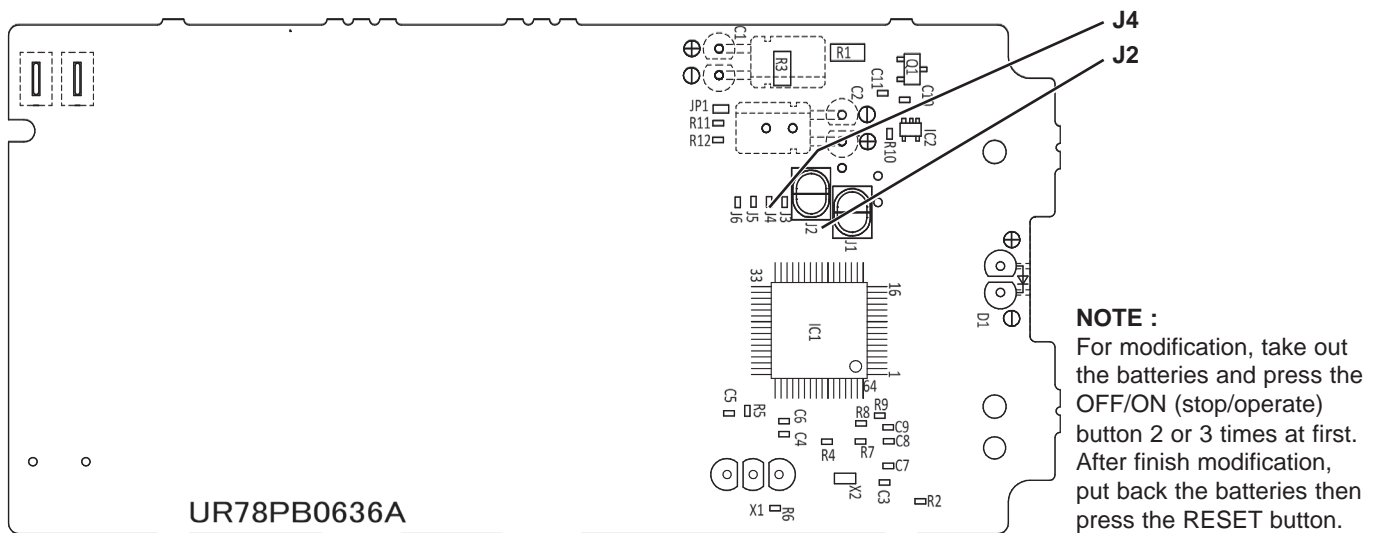

NOTE :
For modification, take out the batteries and press the OFF/ON (stop/operate) button 2 or 3 times at first. After finish modification, put back the batteries then press the RESET button.

The P.C. board has the print "J2" and "J4". Solder "J2" and "J4" according to the number of indoor unit as shown in Table 1. After modification, press the RESET button.

Table 1

	1 unit operation	2 units operation	3 units operation	4 units operation
No. 1 unit	No modification	Same as at left	Same as at left	Same as at left
No. 2 unit	–	Solder J2	Same as at left	Same as at left
No. 3 unit	–	–	Solder J4	Same as at left
No. 4 unit	–	–	–	Solder both J2 and J4

How to set the remote controller exclusively for particular indoor unit

After you turn the breaker ON, the first remote controller that sends the signal to the indoor unit will be regarded as the remote controller for the indoor unit.

The indoor unit will only accept the signal from the remote controller that has been assigned to the indoor unit once they are set.

The setting will be cancelled if the breaker is turned OFF, or the power supply is shut down.

Please conduct the above setting once again after the power has been restored.

MSY-TP35VF MSY-TP50VF

8-3. AUTO RESTART FUNCTION

When the indoor unit is controlled with the remote controller, the operation mode, the set temperature, and the fan speed are memorized by the indoor electronic control P.C. board. "AUTO RESTART FUNCTION" automatically starts operation in the same mode just before the shutoff of the main power.

Operation

- ① If the main power has been cut, the operation settings remain.
- ② After the power is restored, the unit restarts automatically according to the memory.
(However, it takes at least 3 minutes for the compressor to start running.)

How to disable "AUTO RESTART FUNCTION"

- ① Turn off the main power for the unit.
- ② Cut the Jumper wire to JR77 on the indoor electronic control P.C. board. (Refer to 10-7.)

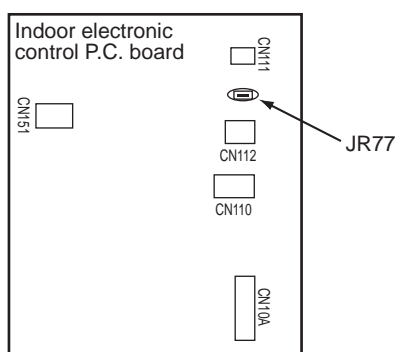

NOTE:

- The operation settings are memorized when 10 seconds have passed after the indoor unit was operated with the remote controller.
- If main power is turned OFF or a power failure occurs while AUTO START/STOP timer is active, the timer setting is cancelled.
- If the unit has been turned OFF with the remote controller before power failure, the auto restart function does not work as the power button of the remote controller is off.
- To prevent the breaker from tripping OFF due to the rush of starting current, systematize other home appliance not to turn ON at the same time.
- When some air conditioners are connected to the same supply system, if they are operated before power failure, the starting current of all the compressors may flow simultaneously at restart. Therefore, the special counter measures are required to prevent the main voltage-drop or the rush of the starting current by adding to the system that allows the units to start one by one.

MSY-TP35VF MSY-TP50VF

1 WIRED REMOTE CONTROLLER

(Option : Example) PAR-33MAA

NOTE: MAC-SL100M-E (option) may be used with this product. (Refer to 2 WIRELESS REMOTE CONTROLLER.)

Display

The main display can be displayed in 2 different modes: "Full" and "Basic."
The initial setting is "Full."

Full mode

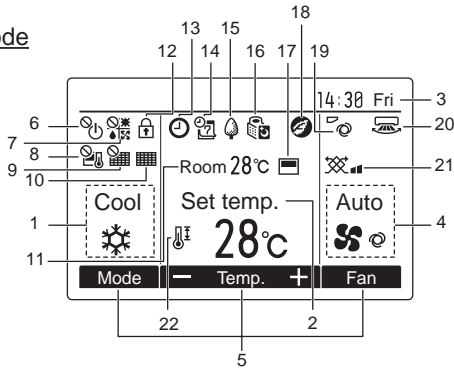

Basic mode

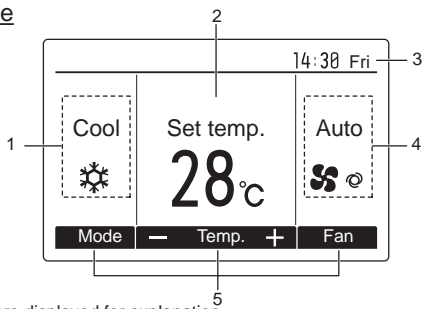

Note: All icons are displayed for explanation.

- 1 **Operation mode**
Indoor unit operation mode appears here.
- 2 **Preset temperature**
Preset temperature appears here.
- 3 **Clock**
(See the Installation Manual.)
Current time appears here.
- 4 **Fan speed**
Fan speed setting appears here.
- 5 **Button function guide**
Functions of the corresponding buttons appear here.
- 6 Appears when the ON/OFF operation is centrally controlled.
- 7 Appears when the operation mode is centrally controlled.
- 8 Appears when the preset temperature is centrally controlled.
- 9 Appears when the filter reset function is centrally controlled.
- 10 Indicates when filter needs maintenance.
- 11 **Room temperature**
(See the Installation Manual.)
Current room temperature appears here.
- 12 Appears when the buttons are locked.
- 13 Appears when the On/Off timer or Night setback function is enabled.
- 14 Appears when the Weekly timer is enabled.
- 15 Appears while the units are operated in the energy-saving mode.
- 16 Appears while the outdoor units are operated in the silent mode.
- 17 Appears when the built-in thermistor on the remote controller is activated to monitor the room temperature (a).
 appears when the thermistor on the indoor unit is activated to monitor the room temperature.
- 18 Appears when the units are operated in the energy-saving mode with 3D i-see Sensor.
- 19 Indicates the vane setting.
- 20 Indicates the louver setting.
- 21 Indicates the ventilation setting.
- 22 Appears when the preset temperature range is restricted.

Controller interface

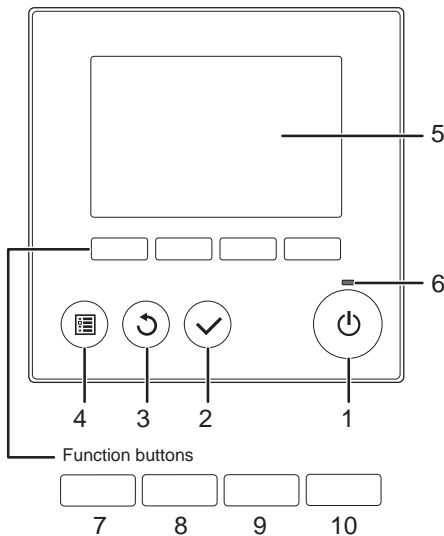

- When the backlight is off, pressing any button turns the backlight on and does not perform its function. (except for the OFF/ON button)
- Most settings (except OFF/ON, mode, fan speed, temperature) can be made from the Menu screen.

- 1 **OFF/ON button**
Press to turn ON/OFF the indoor unit.
- 2 **SELECT button**
Press to save the setting.
- 3 **RETURN button**
Press to return to the previous screen.
- 4 **MENU button**
Press to bring up the Main menu.
- 5 **Backlit LCD**
Operation settings will appear.
When the backlight is off, pressing any button turns the backlight on and it will stay lit for a certain period of time depending on the screen.
- 6 **ON/OFF lamp**
This lamp lights up in green while the unit is in operation. It blinks while the remote controller is starting up or when there is an error.

The functions of the function buttons change depending on the screen. Refer to the button function guide that appears at the bottom of the LCD for the functions they serve on a given screen. When the system is centrally controlled, the button function guide that corresponds to the locked button will not appear.

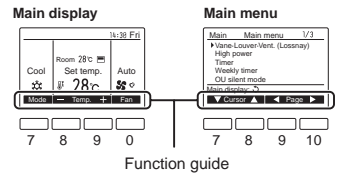

- 7 **Function button [F1]**
Main display: Press to change the operation mode.
Main menu: Press to move the cursor down.
- 8 **Function button [F2]**
Main display: Press to decrease temperature.
Main menu: Press to move the cursor up.
- 9 **Function button [F3]**
Main display: Press to increase temperature.
Main menu: Press to go to the previous page.
- 10 **Function button [F4]**
Main display: Press to change the fan speed.
Main menu: Press to go to the next page.

Menu structure

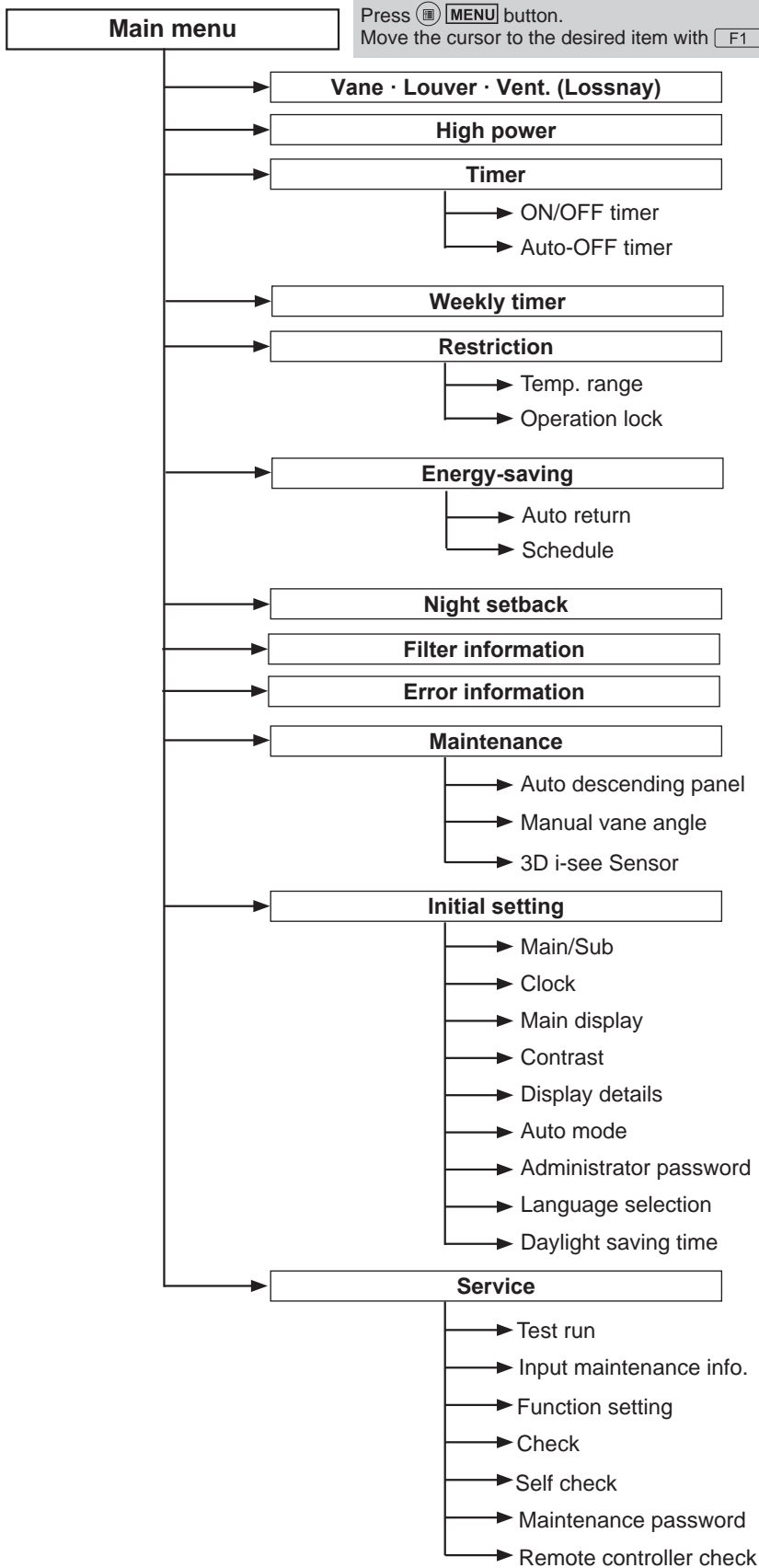

Not all functions are available on all models of indoor units.

Main menu list

Setting and display items		Setting details
Vane · Louver · Vent. (Lossnay)		<p>Use to set the vane angle.</p> <ul style="list-style-type: none"> • Select a desired vane setting from 5 different settings. <p>Use to turn ON/OFF the louver.</p> <p>Not available</p> <p>Use to set the amount of ventilation.</p> <p>Not available</p>
High power		<p>Use to reach the comfortable room temperature quickly.</p> <p>Not available</p>
Timer	ON/OFF timer*	<p>Use to set the operation ON/OFF times.</p> <ul style="list-style-type: none"> • Time can be set in 5-minute increments.
	Auto-Off timer	<p>Use to set the Auto-OFF time.</p> <ul style="list-style-type: none"> • Time can be set to a value from 30 to 240 in 10-minute increments.
Filter information		<p>Use to check the filter status.</p> <p>Not available</p>
Error information		<p>Use to check error information when an error occurs.</p> <ul style="list-style-type: none"> • Check code, error source, refrigerant address, unit model, manufacturing number, contact information (dealer's phone number) can be displayed. (The unit model, manufacturing number, and contact information need to be registered in advance to be displayed.)
Weekly timer*		<p>Use to set the weekly operation ON/OFF times.</p> <ul style="list-style-type: none"> • Up to 8 operation patterns can be set for each day. (Not valid when the ON/OFF timer is enabled.)
Energy saving	Auto return	<p>Use to get the units to operate at the preset temperature after performing energy-saving operation for a specified time period.</p> <ul style="list-style-type: none"> • Time can be set to a value from 30 and 120 in 10-minute increments. (This function will not be valid when the preset temperature ranges are restricted.)
	Schedule*	<p>Set the start/stop times to operate the units in the energy-saving mode for each day of the week, and set the energy-saving rate.</p> <p>Not available</p>
Night setback*		<p>Use to make Night setback settings.</p> <ul style="list-style-type: none"> • Select "Yes" to enable the setting, and "No" to disable the setting. The temperature range and the start/stop times can be set.
Restriction	Temp. range	<p>Use to restrict the preset temperature range.</p> <ul style="list-style-type: none"> • Different temperature ranges can be set for different operation modes.
	Operation lock	<p>Use to lock selected functions.</p> <ul style="list-style-type: none"> • The locked functions cannot be operated.
Maintenance	Auto descending panel	Not available
	Manual vane angle	Not available
	3D i-see Sensor	Not available
Initial setting	Main/Sub	When connecting 2 remote controllers, one of them needs to be designated as a sub controller.
	Clock	Use to set the current time.
	Main display	<p>Use to switch between "Full" and "Basic" modes for the Main display.</p> <ul style="list-style-type: none"> • The initial setting is "Full."
	Contrast	Use to adjust screen contrast.
	Display details	<p>Make the settings for the remote controller related items as necessary.</p> <p>Clock: The initial settings are "Yes" and "24h" format. Temperature: Set either Celsius (°C) or Fahrenheit (°F). Room temp. : Set Show or Hide. Auto mode: Set the Auto mode display or Only Auto display.</p>
	Auto mode	<p>Whether or not to use the AUTO mode can be selected by using the button.</p> <p>This setting is valid only when indoor units with the AUTO mode function are connected.</p>
	Administrator password	<p>The administrator password is required to make the settings for the following items.</p> <ul style="list-style-type: none"> • Timer setting • Energy-saving setting • Weekly timer setting • Restriction setting • Outdoor unit silent mode setting • Night set back
	Language selection	Use to select the desired language.
	Daylight saving time	Sets the daylight saving time.
	Service	Test run
Input maintenance		<p>Select "Input maintenance Info." from the Service menu to bring up the Maintenance information screen. The following settings can be made from the Maintenance Information screen.</p> <ul style="list-style-type: none"> • Model name input • Serial No. input • Dealer information input
Function setting		Not available
Check		<p>Error history: Display the error history and delete the error history. Refrigerant leak check: Not available Smooth maintenance: Not available Request code: Not available</p>
Self check		Error history of each unit can be checked via the remote controller.
Maintenance password		Use to change the maintenance password.
Remote controller check		When the remote controller does not work properly, use the remote controller checking function to troubleshoot the problem.





* Clock setting is required.

INDOOR UNIT DISPLAY SECTION

Operation Indicator lamp

The operation indicator at the right side of the indoor unit indicates the operation state.

- The following indication applies regardless of shape of the indication.

Indication	Operation state	Room temperature
	The unit is operating to reach the set temperature.	About 2°C or more away from set temperature
		
	The room temperature is approaching the set temperature.	About 1 to 2°C from set temperature
		

-  Lit
-  Blinking
-  Not lit

Operation status memory

	Remote controller setting
Operation mode	Operation mode before the power was turned off
Preset temperature	Preset temperature before the power was turned off
Fan speed	Fan speed before the power was turned off

Settable preset temperature range

Operation mode	Preset temperature range
Cool/Dry	16 ~ 31°C
Fan/Ventilation	Not settable

Mode selection

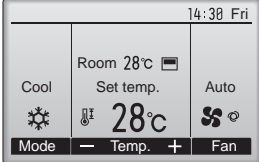





Press **[F1]** button to go through the operation modes in the order of "Cool", "Dry", and "Fan". Select the desired operation mode.

 Cool

 Dry

 Fan

F1 F2 F3 F4

9-1. COOL (❄️) OPERATION

- Press  **OFF/ON** button.
OFF/ON lamp will light up in green and the operation will start.
- Select COOL mode with **[F1]** button.
- Press **[F2]** button to decrease the preset temperature, and **[F3]** button to increase.
The setting range is 16 ~ 31°C.



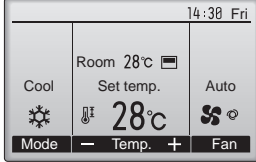

1. Coil frost prevention

The compressor operational frequency is controlled by the temperature of the indoor heat exchanger to prevent the coil from frosting.

When the temperature of indoor heat exchanger becomes too low, the coil frost prevention mode works. The indoor fan operates at the set speed and the compressor stops. This mode continues until the temperature of indoor heat exchanger rises.



F1 F2 F3 F4



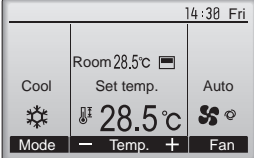





Example display
(Centigrade in 0.5-degree increments)

- Preset temperature will be displayed either in Centigrade in 0.5- or 1-degree increments, or in Fahrenheit, depending on the display mode setting on the remote controller.



9-2. DRY (☀️) OPERATION

- Press  **OFF/ON** button.
OFF/ON lamp will light up in green and the operation will start.
- Select DRY mode with **[F1]** button.
- Press **[F2]** button to decrease the preset temperature, and **[F3]** button to increase.

1. Coil frost prevention

Coil frost prevention works the same way as that in COOL mode. (9-1.1.)

9-3. FAN()OPERATION

- (1) Press  **OFF/ON** button. OFF/ON lamp will light up in green and the operation will start.
- (2) Select FAN mode with  button.
- (3) Press  button to select the desired fan speed. When AUTO, it becomes Low. Only indoor fan operates. Outdoor unit does not operate.

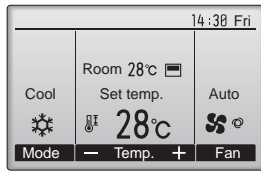

Press  button to go through the fan speeds in the following order.

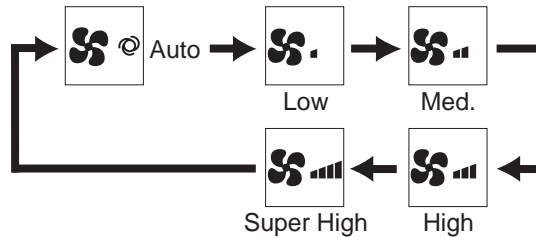

9-4. AUTO VANE OPERATION

1. Horizontal vane



(1) Vane motor drive

These models are equipped with a stepping motor for the horizontal vane. The rotating direction, speed, and angle of the motor are controlled by pulse signals (approximately 12 V) transmitted from indoor microprocessor.

(2) How to set the vane angle

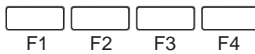
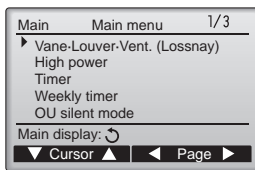
- ① Press the  **MENU** button.
- ② Select "Vane-Louver-Vent. (Lossnay)" with  or  button, and press  button.



- ③ Press  or  button to go through the vane setting options: "Auto", "Step 1", "Step 2", "Step 3", "Step 4", "Step 5" and "Swing", and select the desired setting.

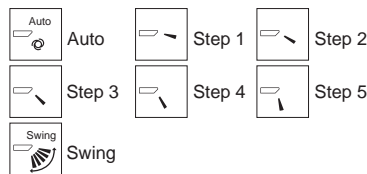
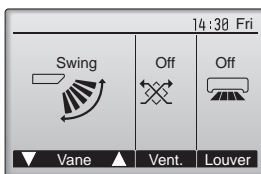

- ④ Press  **RETURN** button to go back to the Main menu.

(3) Positioning

To confirm the standard position, the vane moves until it touches the vane stopper. Then the vane is set to the selected angle.

Confirmation of standard position is performed in the following cases:

- (a) When the operation starts or finishes (including timer operation).
- (b) When the test run starts.

(4) VANE AUTO (Auto) mode

In VANE AUTO mode, the microprocessor automatically determines the vane angle to make the optimum room temperature distribution.

In COOL and DRY operation
Vane angle is fixed to Horizontal position.



(5) STOP (operation OFF) and ON TIMER standby

In the following cases, the horizontal vane returns to the closed position.

- (a) When OFF/ON button is pressed (POWER OFF).
- (b) When the operation is stopped by the emergency operation.
- (c) When ON TIMER is ON standby.

(6) Dew prevention

During COOL or DRY operation with the vane angle at Angle 3 ~ 5 when the compressor cumulative operation time exceeds 1 hour, the vane angle automatically changes to Angle 2 for dew prevention.

(7) SWING (Swing) mode

Select "Swing" to move the vanes up and down automatically.
When set to "Step 1" through "Step 5", the vane will be fixed at the selected angle.

9-5. TIMER OPERATION (ON/OFF TIMER)

The unit automatically turns on or off at the preset time.

Select "Timer" from the Main menu, and press SELECT button (Refer to the appropriate operation manual include with remote controller.).

9-6. EMERGENCY/TEST OPERATION

In the case of test run operation or emergency operation, use EMERGENCY OPERATION switch on the right side of the indoor unit. Emergency operation is available when the remote controller is missing or has failed, or when the batteries in the remote controller are running down. The unit will start and OPERATION INDICATOR lamp will light up.

The first 30 minutes of operation is the test run operation. This operation is for servicing. The indoor fan runs at High speed and the temperature control does not work.

After 30 minutes of test run operation, the system shifts to EMERGENCY COOL MODE with a set temperature of 24°C.

The fan speed shifts to Med.

The coil frost prevention works even in the test run or the emergency operation.

In the test run or emergency operation, the horizontal vane operates in VANE AUTO (Auto) mode.

Emergency operation continues until EMERGENCY OPERATION switch is pressed once or the unit receives any signal from the remote controller. In the latter case, normal operation will start.

NOTE: Do not press EMERGENCY OPERATION switch during normal operation.

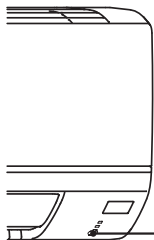

EMERGENCY OPERATION switch



Operation mode	COOL
Set temperature	24°C
Fan speed	Med.
Horizontal vane	Auto

The operation mode is indicated by the Operation Indicator lamp as follows:

Operation Indicator lamp

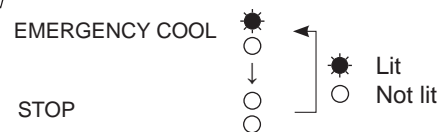

9-7. 3-MINUTE TIME DELAY OPERATION

When the system turns OFF, compressor will not restart for 3 minutes as 3-minute time delay function operates to protect compressor from overload.

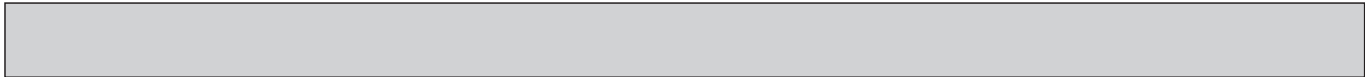

2 WIRELESS REMOTE CONTROLLER (Option : Example) MAC-SL100M-E

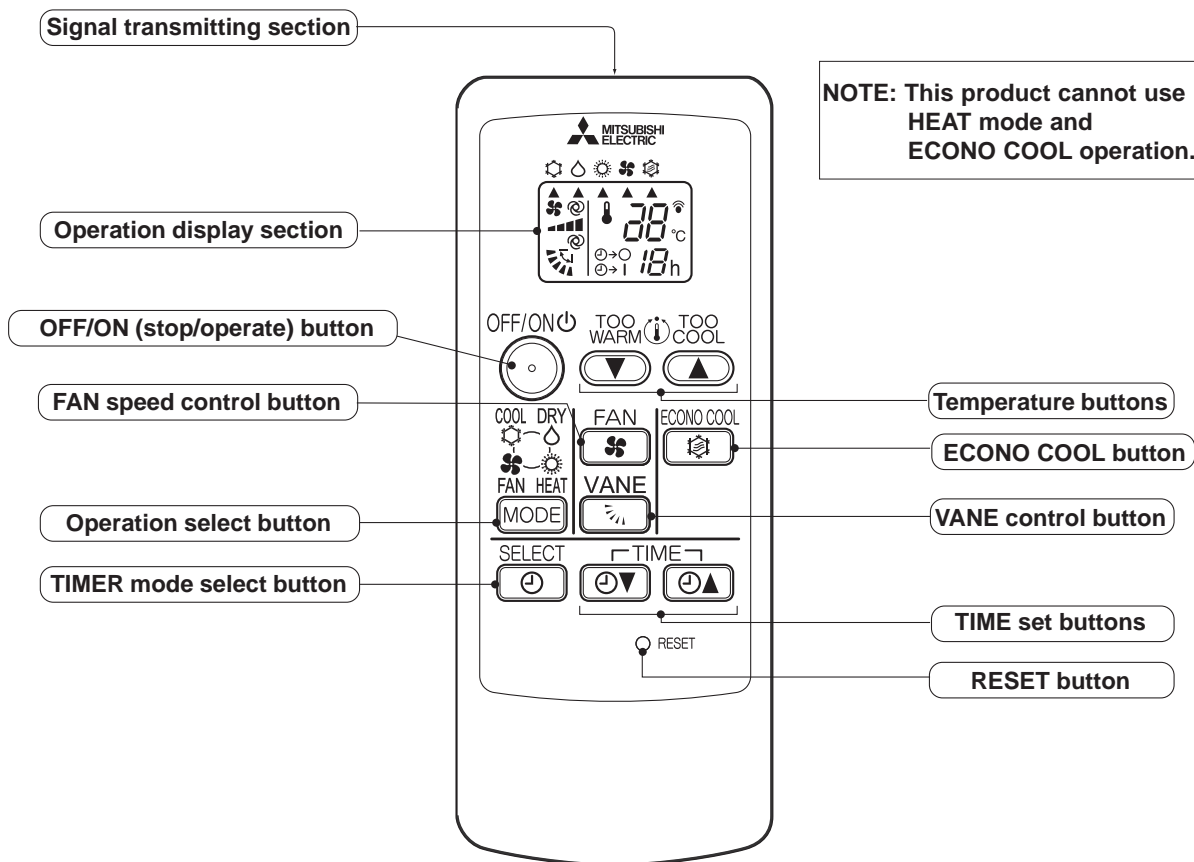

NOTE: Last setting will be stored after the unit is turned OFF with the remote controller. Indoor unit receives the signal of the remote controller with beeps.

INDOOR UNIT DISPLAY SECTION

Operation Indicator lamp

The operation indicator at the right side of the indoor unit indicates the operation state.

- The following indication applies regardless of shape of the indication.

Indication	Operation state	Room temperature
 	The unit is operating to reach the set temperature	About 2°C or more away from set temperature
 	The room temperature is approaching the set temperature	About 1 to 2°C from set temperature

- Lit
- Blinking
- Not lit

9-8. COOL (❄️) OPERATION

- (1) Press OFF/ON (stop/operate) button.
OPERATION INDICATOR lamp of the indoor unit turns on with a beep tone.
- (2) Select COOL mode with Operation select button.
- (3) Press Temperature buttons (TOO WARM or TOO COOL button) to select the desired temperature.
The setting range is 16 - 31°C.

1. Coil frost prevention

The compressor operational frequency is controlled by the temperature of the indoor heat exchanger to prevent the coil from frosting.

When the temperature of indoor heat exchanger becomes too low, the coil frost prevention mode works. The indoor fan operates at the set speed and the compressor stops. This mode continues until the temperature of indoor heat exchanger rises.

2. Low outside temperature operation

When the outside temperature is lower, low outside temperature operation starts, and the outdoor fan slows or stops.

9-9. DRY (☁️) OPERATION

- (1) Press OFF/ON (stop/operate) button.
OPERATION INDICATOR lamp of the indoor unit turns on with a beep tone.
- (2) Select DRY mode with Operation select button.
- (3) The set temperature is determined from the initial room temperature.

1. Coil frost prevention

Coil frost prevention works the same way as that in COOL mode. (9-8.1.)

2. Low outside temperature operation

Low outside temperature operation works the same way as that in COOL mode. (9-8.2.)

9-10. FAN (🌀) OPERATION

- (1) Press OFF/ON (stop/operate) button.
OPERATION INDICATOR lamp of the indoor unit turns ON with a beep tone.
- (2) Select FAN mode with Operation select button.
- (3) Select the desired fan speed. When AUTO, it becomes Low.
Only indoor fan operates. Outdoor unit does not operate.

9-11. AUTO VANE OPERATION

1. Horizontal vane

- (1) Vane motor drive
These models are equipped with a stepping motor for the horizontal vane. The rotating direction, speed, and angle of the motor are controlled by pulse signals (approximately 12 V) transmitted from indoor microprocessor.
- (2) The horizontal vane angle and mode change as follows by pressing VANE control button.

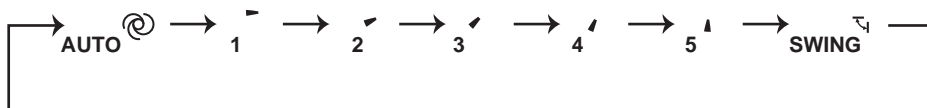

- (3) Positioning
To confirm the standard position, the vane moves until it touches the vane stopper. Then the vane is set to the selected angle.

Confirmation of standard position is performed in the following cases:

- (a) When the operation starts or finishes (including timer operation).
- (b) When the test run starts.
- (c) When standby mode (only during multi system operation) starts or finishes.

(4) VANE AUTO (🌀) mode

In VANE AUTO mode, the microprocessor automatically determines the vane angle to make the optimum room temperature distribution.

In COOL and DRY operation



Vane angle is fixed to Horizontal position.



- (5) STOP (operation OFF) and ON TIMER standby
 In the following cases, the horizontal vane returns to the closed position.
 (a) When OFF/ON (stop/operate) button is pressed (POWER OFF).
 (b) When the operation is stopped by the emergency operation.
 (c) When ON TIMER is ON standby.
- (6) Dew prevention
 During COOL or DRY operation with the vane angle at Angle 3 ~ 5 when the compressor cumulative operation time exceeds 1 hour, the vane angle automatically changes to Angle 2 for dew prevention.
- (7) SWING (↕) mode
 By selecting SWING mode with VANE control button, the horizontal vane swings vertically.

9-12. TIMER OPERATION (ON/OFF TIMER)

1. How to set the timer

- (1) Press OFF/ON (stop/operate) button to start the air conditioner.
- (2) Select the timer mode by pressing the  button during operation.
 Each time this button is pressed, the timer mode is changed in sequence:
 ○→○ (OFF TIMER) → ○→| (ON TIMER) → TIMER RELEASE
- (3) Set the time of the timer using the  button.
 Each time this button is pressed, the set time increase or decrease by 1 hour to 12 hours.

2. To release the timer

Press the  button until ○→○ (OFF TIMER) and ○→| (ON TIMER) are not displayed.

NOTE :

- The OFF TIMER and the ON TIMER cannot be set at the same time.
- The displayed time is the time remaining and will decrease in 1-hour increments as time passes.

9-13. EMERGENCY/TEST OPERATION

In the case of test run operation or emergency operation, use the emergency operation switch on the right side of the indoor unit. Emergency operation is available when the remote controller is missing or has failed, or when the batteries in the remote controller are running down. The unit will start and OPERATION INDICATOR lamp will light up. The first 30 minutes of operation is the test run operation. This operation is for servicing. The indoor fan runs at High speed and the temperature control does not work. After 30 minutes of test run operation, the system shifts to EMERGENCY COOL with a set temperature of 24°C. The fan speed shifts to Med.

The coil frost prevention works even in the test run or the emergency operation.

In the test run or emergency operation, the horizontal vane operates in VANE AUTO (@) mode.

Emergency operation continues until the emergency operation switch is pressed once or twice or the unit receives any signal from the remote controller. In the latter case, normal operation will start.

NOTE: Do not press the emergency operation switch during normal operation.

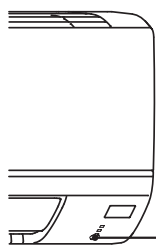

EMERGENCY OPERATION switch 

Operation mode	COOL
Set temperature	24°C
Fan speed	Med.
Horizontal vane	Auto

The operation mode is indicated by the Operation Indicator lamp as follows:

Operation Indicator lamp

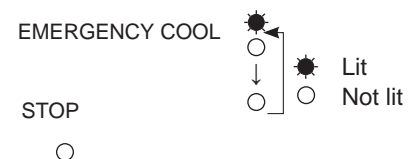

9-14. 3-MINUTE TIME DELAY OPERATION

When the system turns OFF, compressor will not restart for 3 minutes as 3-minute time delay function operates to protect compressor from overload.

MSY-TP35VF MSY-TP50VF**10-1. CAUTIONS ON TROUBLESHOOTING****1. Before troubleshooting, check the following:**

- 1) Check the power supply voltage.
- 2) Check the indoor/outdoor connecting wire for miswiring.

2. Take care of the following during servicing

- 1) Before servicing the air conditioner, be sure to turn OFF the main unit first with the remote controller, and then after confirming the horizontal vane is closed, turn OFF the breaker and/or disconnect the power plug.
- 2) Be sure to turn OFF the power supply before removing the front panel, the cabinet, the top panel, and the P.C. board.
- 3) When removing the P.C. board, hold the edge of the board with care NOT to apply stress on the components.
- 4) When connecting or disconnecting the connectors, hold the connector housing. DO NOT pull the lead wires.

<Incorrect>

**Lead wiring**

<Correct>

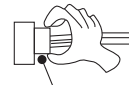
**Connector housing****3. Troubleshooting procedure**

- 1) Check if the OPERATION INDICATOR lamp on the indoor unit is blinking ON and OFF to indicate an abnormality. To make sure, check how many times the OPERATION INDICATOR lamp is blinking ON and OFF before starting service work.
- 2) Before servicing, verify that all connectors and terminals are connected properly.
- 3) When the electronic control P.C. board seems to be defective, check for disconnection of the copper foil pattern and burnt or discolored components.
- 4) When troubleshooting, Refer to 10-2, 10-3 and 10-4.

10-2. FAILURE MODE RECALL FUNCTION

Outline of the function

This air conditioner can memorize the abnormal condition which has occurred once.

Even though LED indication listed on the troubleshooting check table (10-4.) disappears, the memorized failure details can be recalled.

This mode is very useful when the unit needs to be repaired for the abnormality which does not recur.

1. Flow chart of failure mode recall function for the indoor/outdoor unit

NOTE: Use the wireless remote controller of MSZ-DW25VF -[E1] (Refer to parts catalog OBB905.).

The remote controller has the indication of "HEAT" and a button for it, but HEAT mode cannot be used since MSY-TP series are cooling only model.

The remote controller has the indication of "ECONO COOL" and a button for it, but ECONO COOL mode cannot be used since it is not available on MSY-TP series.

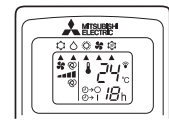
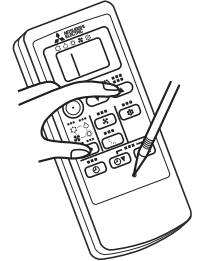

Operational procedure

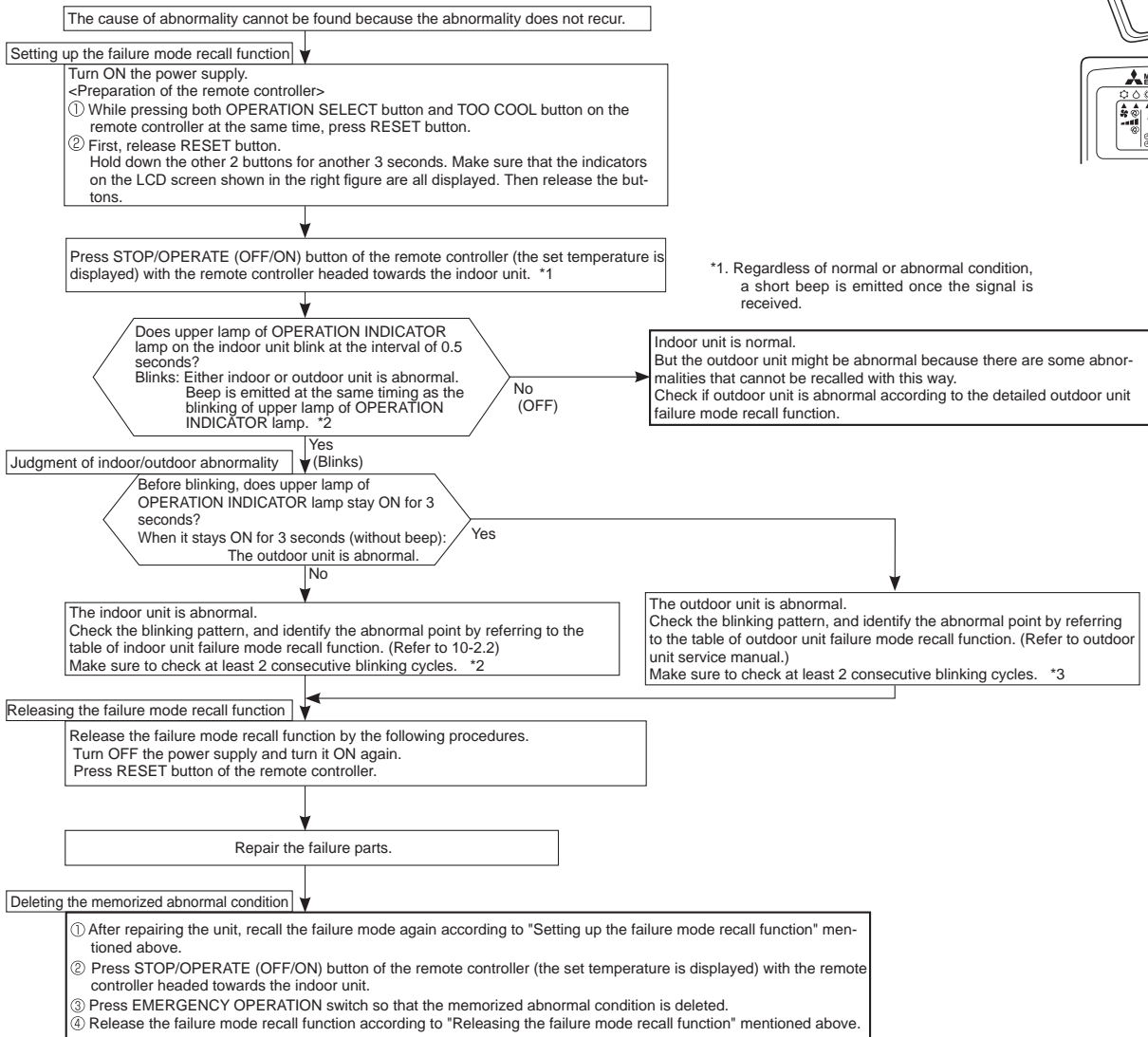

NOTE: 1. Make sure to release the failure mode recall function after it is set up, otherwise the unit cannot operate properly.
2. If the abnormal condition is not deleted from the memory, the last abnormal condition is kept memorized.

*2. Blinking pattern when the indoor unit is abnormal:

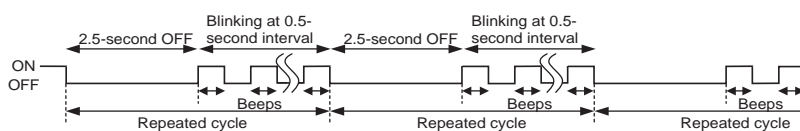

*3. Blinking pattern when the outdoor unit is abnormal:

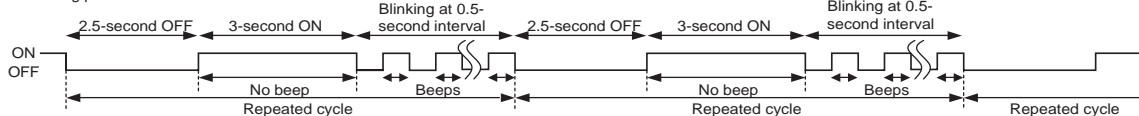

10-3. INSTRUCTION OF TROUBLESHOOTING

*1 "Test Run operation" means the operation within 30 minutes after EMERGENCY OPERATION switch is pressed.

If blinking of OPERATION INDICATOR lamp cannot be checked, it can be checked with failure mode recall function.

*2 There is possibility that diesel explosion may occur due to the air mixed in the refrigerant circuit. First, ensure that there are no leakage points on the valves, flare connections, etc. that allow the air to flow into the refrigerant circuit, or no blockage points (e.g. clogged or closed valves) in the refrigerant circuit that cause an increase in pressure. If there is no abnormal point like above and the system operates cooling mode normally, the indoor thermistor might have a problem, resulting in false detection. Check both the indoor coil thermistor and the room temperature thermistor, and replace faulty thermistor(s), if any. (Do not start the operation again without repair to prevent hazards.)

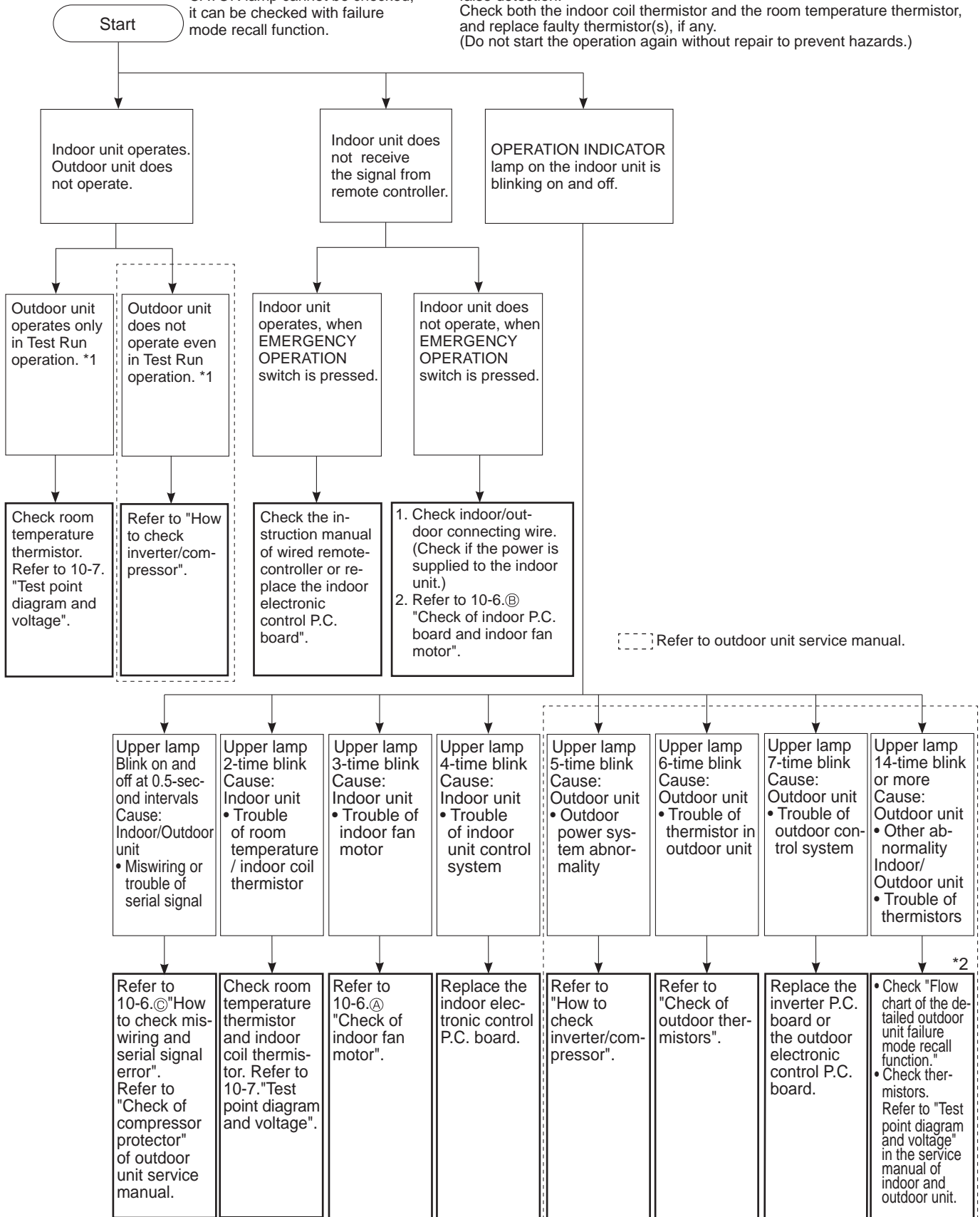

10-4. TROUBLESHOOTING CHECK TABLE

Before taking measures, make sure that the symptom reappears for accurate troubleshooting.
When the indoor unit has started operation and detected an abnormality of the following condition (the first detection after the power ON), the indoor fan motor turns OFF and OPERATION INDICATOR lamp blinks.

OPERATION INDICATOR

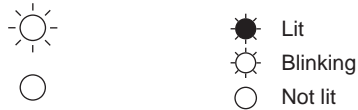

No.	Abnormal point	Operation indicator lamp	Symptom	Condition	Remedy	Error Code
1	Miswiring or serial signal	Upper lamp blinks. 0.5-second ON ●○●○●○●○ 0.5-second OFF	Indoor unit and outdoor unit do not operate.	The serial signal from the outdoor unit is not received for 6 minutes.	<ul style="list-style-type: none"> Refer to 10-6. © "How to check miswiring and serial signal error". Refer to "Check of compressor protector" of outdoor unit service manual. 	E6, E7, E8, E9, EC
2	Indoor coil thermistor Room temperature thermistor	Upper lamp blinks. 2-time blink ●○●○○○○○●○●○●○ 2.5-second OFF		The indoor coil or the room temperature thermistor is short or open circuit.	<ul style="list-style-type: none"> Refer to the characteristics of indoor coil thermistor, and the room temperature thermistor (10-7.). 	P2, P9, PD P1
3	Indoor fan motor	Upper lamp blinks. 3-time blink ●○●○●○○○○○●○●○●○ 2.5-second OFF		The rotational frequency feedback signal is not emitted during the indoor fan operation.	<ul style="list-style-type: none"> Refer to 10-6. Ⓐ "Check of indoor fan motor". 	Pb
4	Indoor control system	Upper lamp blinks. 4-time blink ●○●○●○●○○○○○●○●○●○ 2.5-second OFF		It cannot properly read data in the nonvolatile memory of the indoor electronic control P.C. board.	<ul style="list-style-type: none"> Replace the indoor electronic control P.C. board. 	Fb
5	Outdoor power system	Upper lamp blinks. 5-time blink ●○●○●○●○○○○○●○●○●○ 2.5-second OFF		It consecutively occurs 3 times that the compressor stops for overcurrent protection or start-up failure protection within 1 minute after start-up.	<ul style="list-style-type: none"> Refer to "How to check of inverter/compressor". Refer to outdoor unit service manual Check the stop valve. 	UP
6	Outdoor thermistors	Upper lamp blinks. 6-time blink ●○●○●○●○●○○○○○●○●○●○ 2.5-second OFF		The outdoor thermistors short or open circuit during the compressor operation.	<ul style="list-style-type: none"> Refer to "Check of outdoor thermistor". Refer to outdoor unit service manual. 	U3, U4
7	Outdoor control system	Upper lamp blinks. 7-time blink ●○●○●○●○●○○○○○●○●○●○ 2.5-second OFF		It cannot properly read data in the nonvolatile memory of the inverter P.C. board or the outdoor electronic control P.C. board.	<ul style="list-style-type: none"> Replace the inverter P.C. board or the outdoor electronic control P.C. board. Refer to outdoor unit service manual. 	FC, U6, U9, Ed
8	Other abnormality *2 on 10-3	Upper lamp blinks. 14-time blink or more ●○●○●○●○●○●○●○●○●○●○●○●○●○●○ 2.5-second OFF		An abnormality other than above mentioned is detected. An abnormality of the indoor thermistors, the ambient temperature thermistor is detected.	<ul style="list-style-type: none"> Check the stop valve. Check the abnormality in detail using the failure mode recall function for outdoor unit. Refer to TEST POINT DIAGRAM AND VOLTAGE" on the service manual of indoor and outdoor unit for the characteristics of the thermistors. (Do not start the operation again without repair to prevent hazards.) 	U0, U1, U2, U5, U7, U8, UA, Ub, UC, Ud, UE, UF, UH, UJ, UL, UU, P8, PA, PE, PL, EJ, EF*
9	Outdoor control system	Upper lamp lights up ●	Outdoor unit does not operate	It cannot properly read data in the nonvolatile memory of the inverter P.C. board or the outdoor electronic control P.C. board.	<ul style="list-style-type: none"> Check the blinking pattern of the LED on the inverter P.C. board or the outdoor electronic control P.C. board. 	

* Connection with interface MAC-397IF-E

10-5. TROUBLESHOOTING CRITERION OF MAIN PARTS
MSY-TP35VF MSY-TP50VF

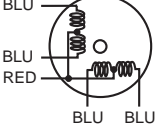
Part name	Check method and criterion	Figure		
Room temperature thermistor (RT11)	Measure the resistance with a multimeter.			
Indoor coil thermistor (RT12, RT13)	Refer to 10-7. "Test point diagram and voltage", "2. Indoor electronic control P.C. board", for the chart of thermistor.			
Indoor fan motor (MF/ MF11)	Check 10-6.㉔.			
Vane motor (MV)	Measure the resistance between the terminals with a multimeter. (Part temperature 10 ~ 30°C)			
	<table border="1" data-bbox="391 582 1045 649"> <thead> <tr> <th data-bbox="391 582 726 616">Color of the lead wire</th> <th data-bbox="726 582 1045 616">Normal</th> </tr> </thead> <tbody> <tr> <td data-bbox="391 616 726 649">RED - BLU</td> <td data-bbox="726 616 1045 649">235 ~ 255 Ω</td> </tr> </tbody> </table>		Color of the lead wire	Normal
Color of the lead wire	Normal			
RED - BLU	235 ~ 255 Ω			

10-6. TROUBLESHOOTING FLOW

A Check of indoor fan motor

The indoor fan motor error has occurred, and the indoor fan does not operate.

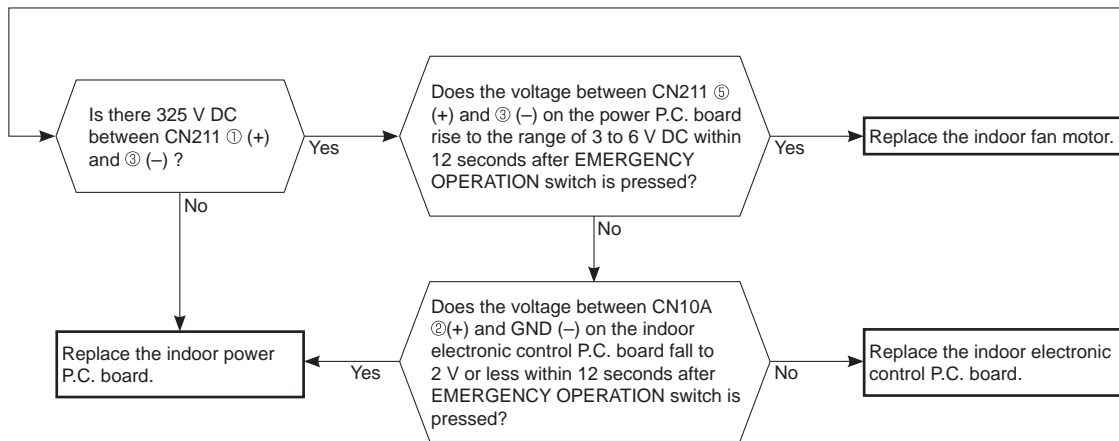
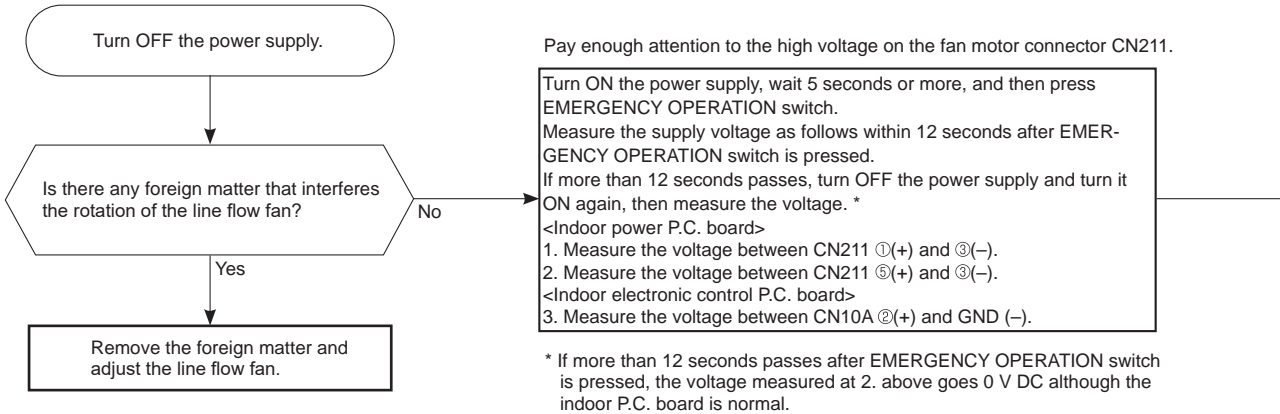

The indoor fan motor error has occurred, and the indoor fan repeats "12-second ON and 30-second OFF" 3 times, and then stops.

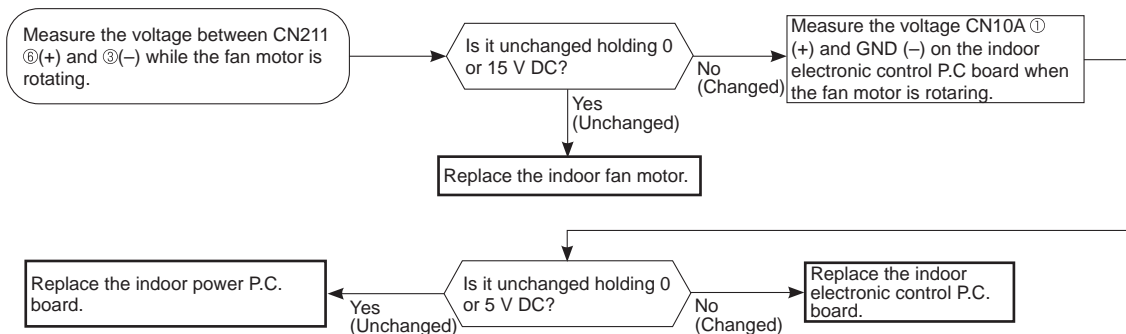

B Check of indoor P.C. board and indoor fan motor

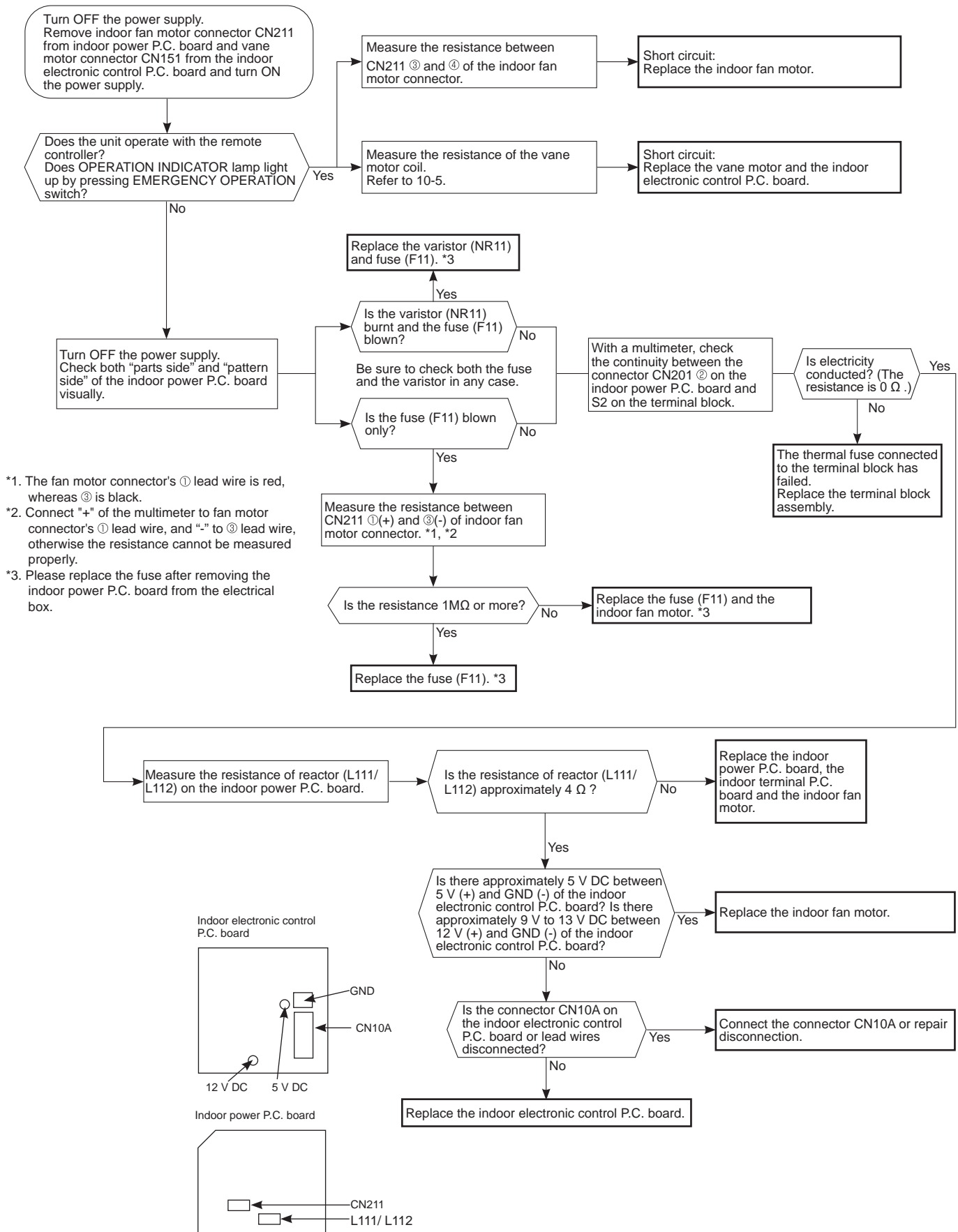

C How to check miswiring and serial signal error

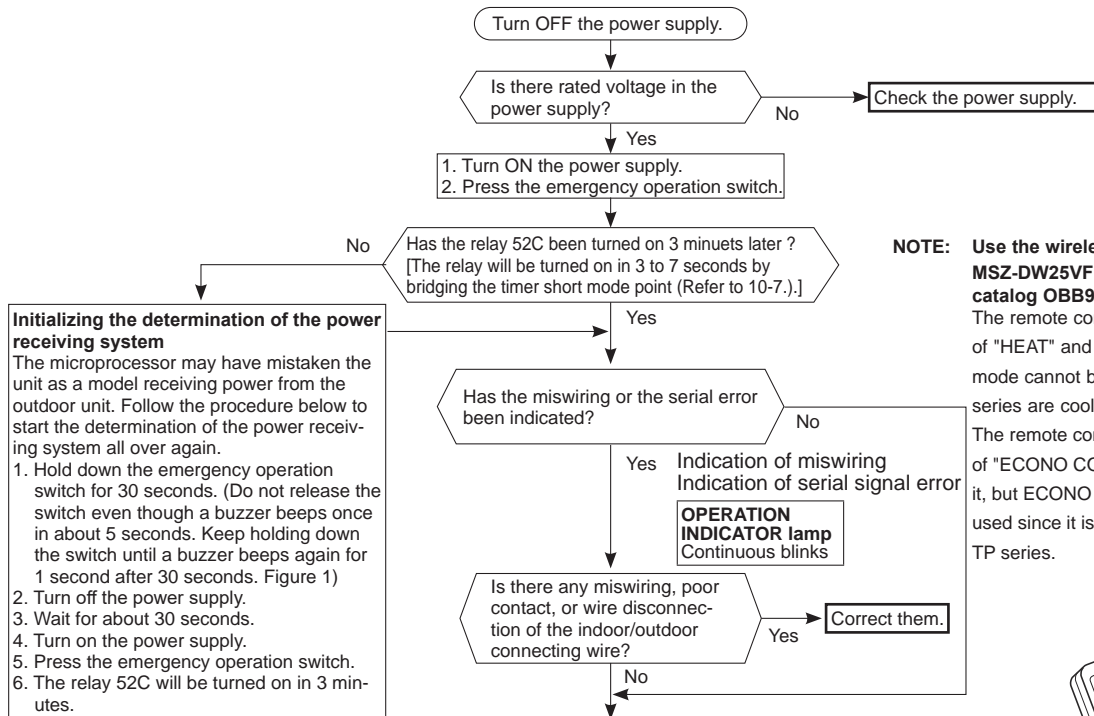

NOTE: Use the wireless remote controller of **MSZ-DW25VF -[E1]** (Refer to parts catalog **OBB905**.)
The remote controller has the indication of "HEAT" and a button for it, but HEAT mode cannot be used since MSY-TP series are cooling only model.
The remote controller has the indication of "ECONO COOL" and a button for it, but ECONO COOL mode cannot be used since it is not available on MSY-TP series.

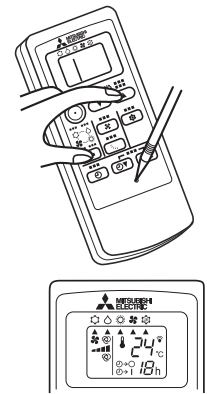
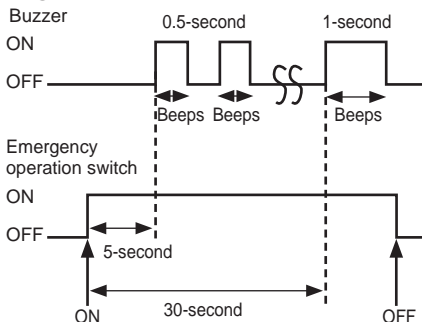

Figure 1



Turn OFF the power supply. Make sure again that the indoor/outdoor connecting wire is correctly connected. With the indoor/outdoor connecting wire connected, bridge between S2 and S3 on the outdoor terminal block. *1

B <Preparation of the remote controller>

- ① While pressing both OPERATION SELECT button and TOO COOL button on the remote controller at the same time, press RESET button.
- ② First, release RESET button. Hold down the other two buttons for another 3 seconds. Make sure that the indicators on the LCD screen shown in the right figure are all displayed. Then release the buttons. (Setting up the failure mode recall function)

Aim the remote controller at the indoor unit, and press OPERATE (OFF/ON) button. The relay 52C will be turned on, and the outdoor unit will be energized.

*1 Make sure that the wiring is correct. If the procedure is performed without correcting miswiring, it may lead to damage to the P.C. board.

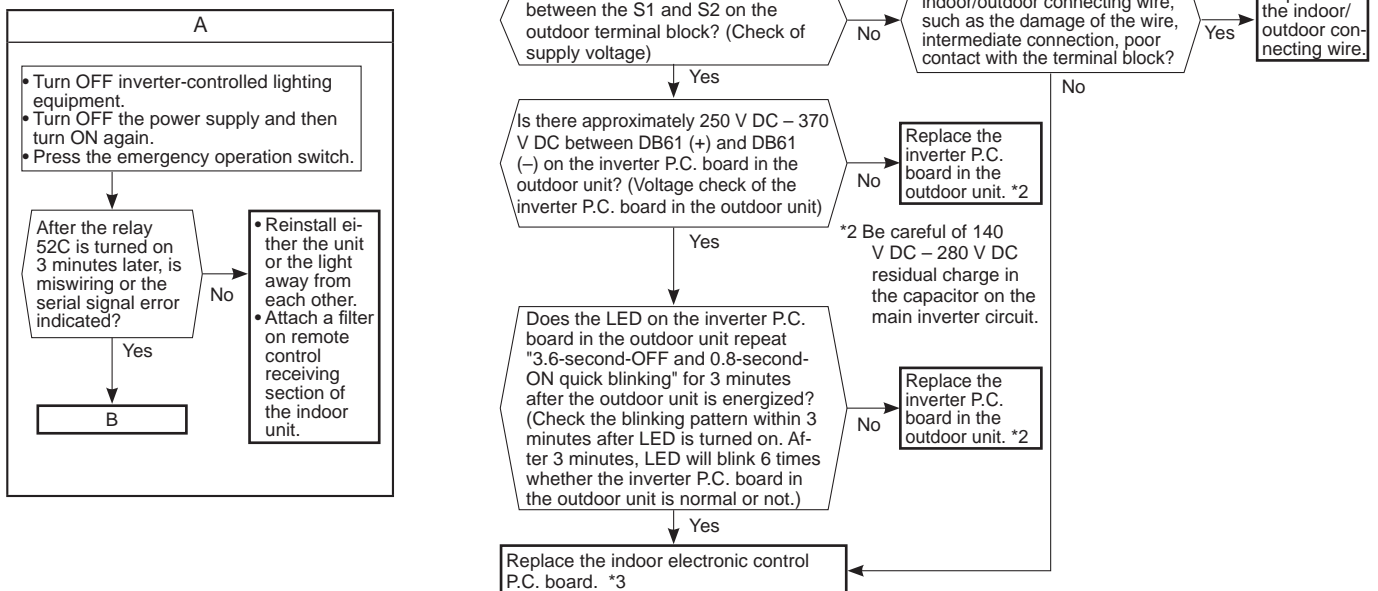

*3 Be sure to release the failure-mode recall function after checking.

D Electromagnetic noise enters into TV sets or radios

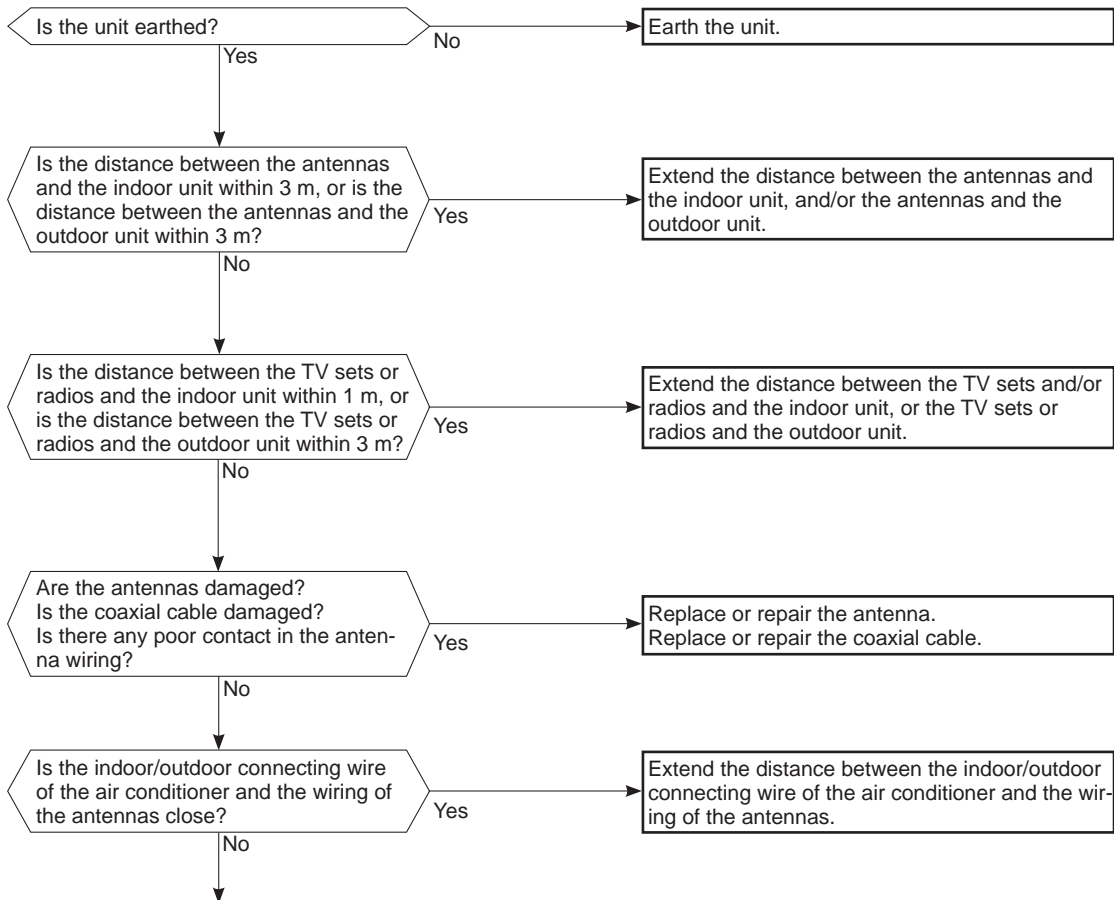

<Detaching method of the terminal with locking mechanism>

The terminal which has the locking mechanism can be detached as shown below.

There are 2 types of the terminal with locking mechanism.

The terminal without locking mechanism can be detached by pulling it out.

Check the shape of the terminal before detaching.

(1) Slide the sleeve and check if there is a locking lever or not.

(2) The terminal with this connector shown below has the locking mechanism.

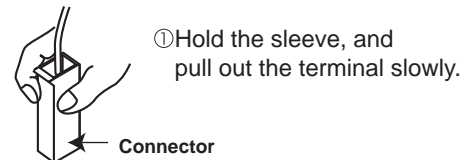
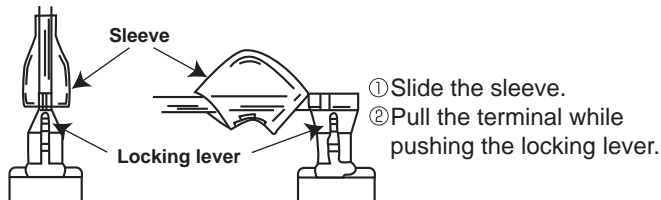

11-1. MSY-TP35VF MSY-TP50VF

NOTE: Turn OFF the power supply before disassembly.

→ : Indicates the visible parts in the photos/figures.
---→ : Indicates the invisible parts in the photos/figures.

OPERATING PROCEDURE	PHOTOS/FIGURES
<p>1. Removing the panel</p> <p>(1) Remove the screw caps on the panel and remove the screws of the panel.</p> <p>(2) Pull the panel slightly toward you, and then remove the panel by pushing it upward.</p>	<p>Photo 1</p> <p>Front panel</p> <p>Screws of the panel</p>

OPERATING PROCEDURE

2. Removing the indoor power P.C. board and the electrical box

- (1) Remove the panel. (Refer to section 1.) Remove the right corner box.
- (2) Disconnect the following connectors:
 - <Indoor electronic control P.C. board>
 - CN151 (Vane motor)
 - CN112 (Indoor coil thermistor)
 - CN10A (To the indoor power P.C. board)
- (3) Unhook the catch on the left side of the control P.C. board holder. Pull the control P.C. board holder as if opening the door at 90 degrees. Remove the control P.C. board holder from the axial rod on the electrical box.
- (4) Remove the screw of the V.A. clamp.
- (5) Remove the V.A. clamp and the indoor/outdoor connecting wire.
- (6) Remove the screws of the earth plate. (Photo 2)
- (7) Remove the indoor coil thermistor from the water cover.
- (8) Disengage the hooks of the water cover and remove the water cover.
- (9) Remove the screw of the electrical cover and remove the electrical cover.
- (10) Disconnect the CN211 (Indoor fan motor) from the indoor power P.C. board.
- (11) Remove the upper catch of the electrical box, and pull out the electrical box.
 - * To attach the electrical box, pass the wires connecting the indoor power P.C. board and the indoor electronic control P.C. board through A. Pass the lead wires of the fan motor through B as shown in the Photo 3.
- (12) Disconnect the following connectors and tabs.
 - <Indoor power P.C. board>
 - CN201, TAB1, TAB2 (Terminal block)
 - CN20A (To the indoor electronic control P.C. board)

PHOTOS/FIGURES

Photo 2

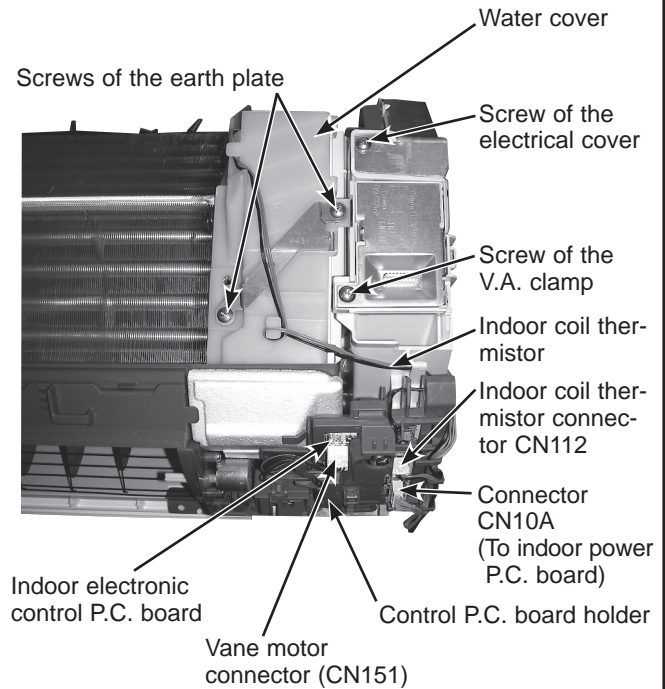
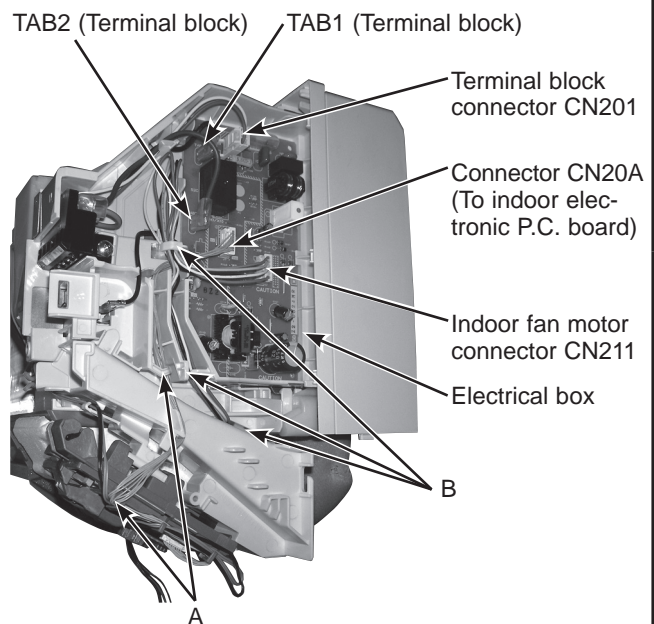

Photo 3



OPERATING PROCEDURE

3. Removing the indoor electronic control P.C. board

- (1) Remove the panel. (Refer to section 1.) Remove the right corner box.
- (2) Disconnect the following connectors:
<Indoor electronic control P.C. board>
CN151 (Vane motor)
CN112 (Indoor coil thermistor)
CN10A (To the indoor power P.C. board)
- (3) Unhook the catch on the left side of the control P.C. board holder. Pull the control P.C. board holder as if opening the door at 90 degrees. Remove the control P.C. board holder from the axial rod on the electrical box.
- (4) Remove the room temperature thermistor from the back side of the control P.C. board holder.
- (5) Unhook the catches of the control P.C. board holder, and open the control P.C. board holder.
- (6) Remove the indoor electronic control P.C. board from the control P.C. board holder.

PHOTOS/FIGURES

Photo 4

Control P.C. board holder (Inside)

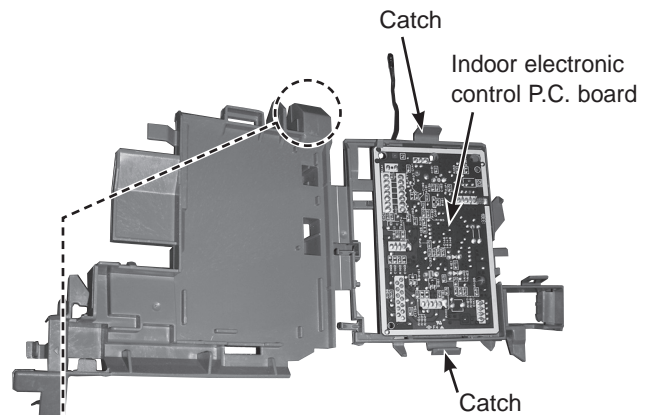

Control P.C. board holder (Back side)

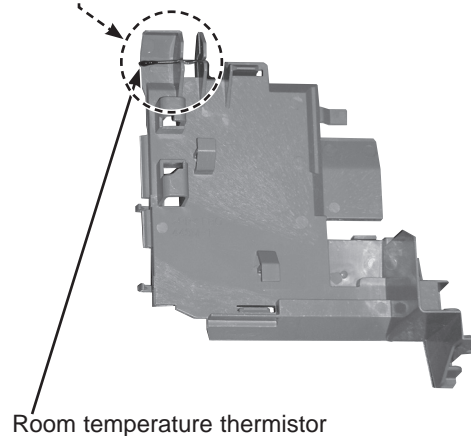

4. Removing the vane motor

- (1) Remove the panel. (Refer to section 1.) Remove the corner box.
- (2) Remove the control P.C. board holder, water cover and the electrical box. (Refer to section 2.)
- (3) Pull out the drain hose from the nozzle assembly and remove the nozzle assembly.
- (4) Remove the screws of the vane motor and remove the vane motor.
- (5) Disconnect the connector from the vane motor.

Photo 5



OPERATING PROCEDURE

5. Removing the indoor fan motor, the indoor coil thermistor and the line flow fan

- (1) Remove the panel. (Refer to section 1.) Remove the corner box.
- (2) Remove the control P.C. board holder, the water cover, the electrical box and the nozzle assembly. (Refer to section 2.)
- (3) Loosen the screw fixing the line flow fan.
- (4) Remove the screws fixing the motor bed.
- (5) Remove the motor bed together with the indoor fan motor and the motor band.
- (6) Disconnect the lead wire of the fan motor from the motor band.
- (7) Disengage the hooks of the motor band and remove the motor band. Pull out the indoor fan motor.
- (8) Remove the indoor coil thermistor from the heat exchanger.
 - * Install the indoor coil thermistor in its former position when assembling it.
- (9) Remove the screws fixing the left side and upper right side of the heat exchanger.
- (10) Lift the heat exchanger, and pull out the line flow fan to the lower-left.
 - * When attaching the line flow fan, screw the line flow fan so 4 mm gap is provided between the right end of the line flow fan and the right wall of the air passage of the box (Figure 1).

Figure 1

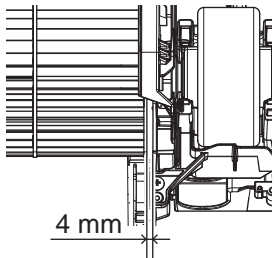
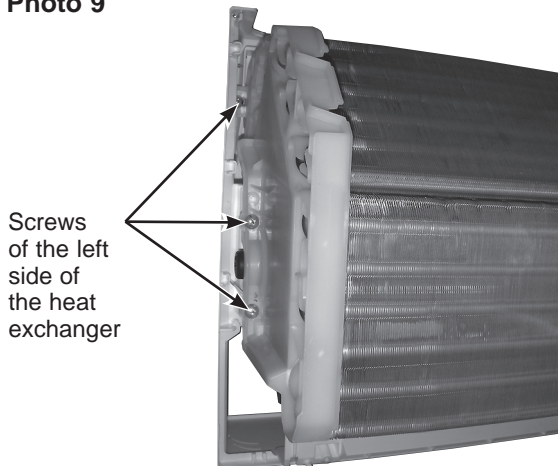

Photo 9



PHOTOS/FIGURES

Photo 6

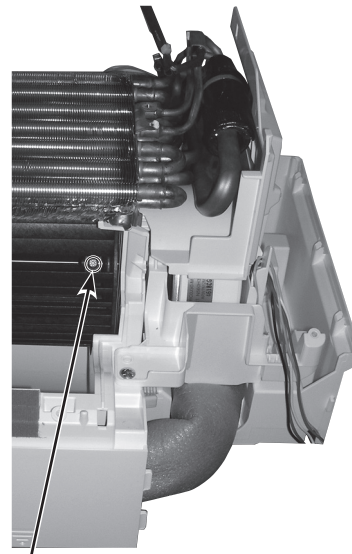

Photo 7

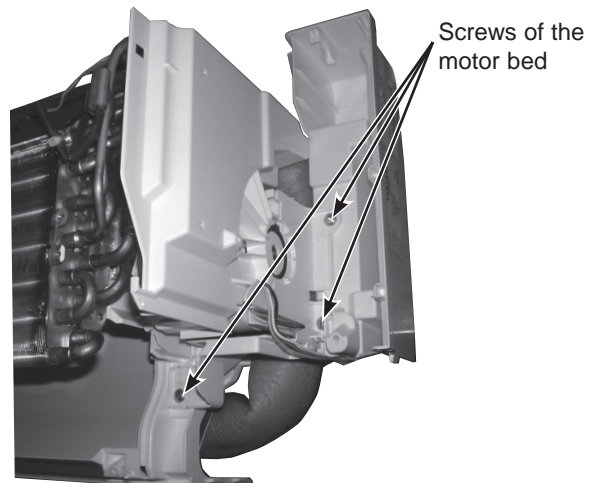
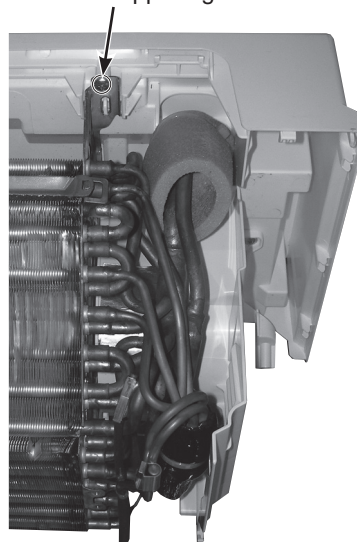

Photo 8

Screw of the upper right side of the heat exchanger



Fixing the indoor coil thermistor

* There are 2 forms of parts for fixing the indoor coil thermistor.

Clip shape



Holder shape



When fixing the indoor coil thermistor to the clip-shape/holder-shape part, the lead wire should point down.

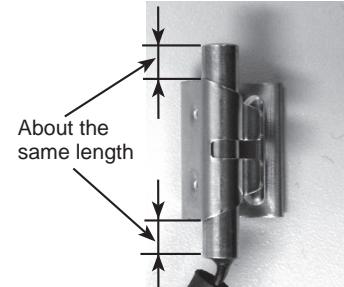

Position and procedure for mounting the clip-shape part

1. Set the indoor coil thermistor in the center of the clip-shape part.

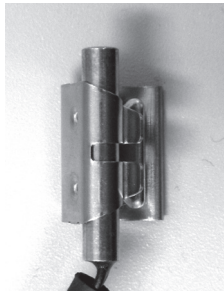

2. Check the (marked) mounting position.



3. Mount the clip-shape part.



NOTE:

- Take care to avoid loss and accidental falling of the clip-shape part inside the unit.
- Mount the clip-shape part on the marked position.
- Do not pull the lead wire when removing the indoor coil thermistor.

mitsubishi electric corporation

HEAD OFFICE: TOKYO BUILDING, 2-7-3, MARUNOUCHI, CHIYODA-KU, TOKYO 100-8310, JAPAN

© Copyright 2018 MITSUBISHI ELECTRIC CORPORATION

Issued: Apr. 2023. No. OBH816 REVISED EDITION-C

Issued: Sep. 2022. No. OBH816 REVISED EDITION-B

Issued: Sep. 2020. No. OBH816 REVISED EDITION-A

Published: Oct. 2018. No. OBH816

Made in Japan

Specifications are subject to change without notice.