

## Figure

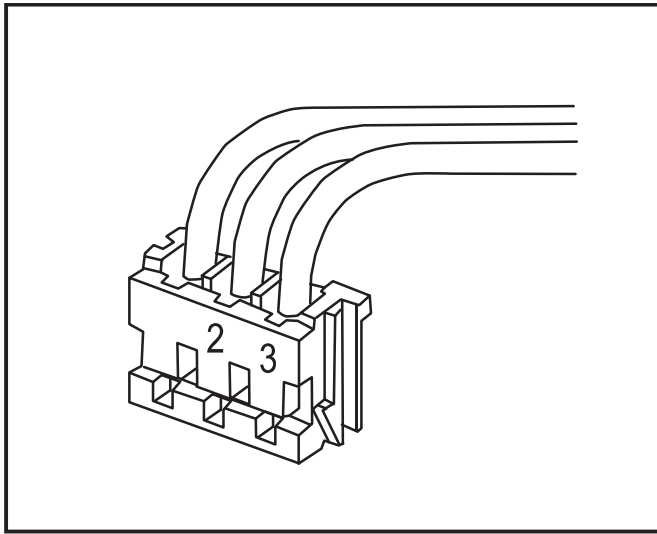

## Descriptions

•Operation other than ON/OFF (adjustment of temperature, fan speed, and air direction, for example) can be performed even when remote controller operation is prohibited.

## Applicable Models

- S-series models
- P-series models

## Specifications

Function	ON/OFF by external signal External signal ON (remote control disabled) / OFF (remote control enabled) switch able
Input signal	No-voltage contact (ON/OFF level signal)
Connector	3P (connected to CN32 on outdoor unit control board)
Cable type	3-wire cable, for extension: Sheathed vinyl cord or cable (0.5 to 1.25mm <sup>2</sup> )
Cable length	2m (max. 10m when extended locally)

## Dimensions

Unit : mm

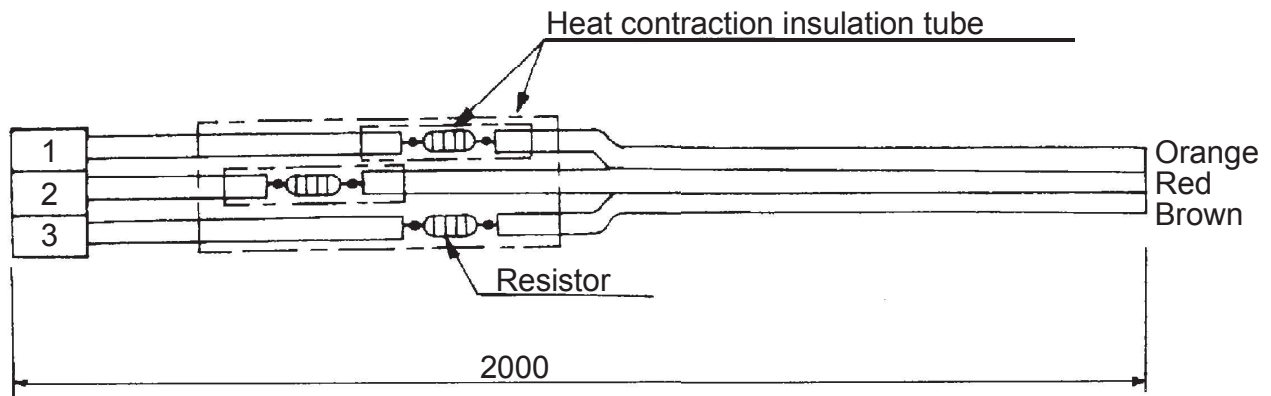

OPTIONAL PARTS

INDOOR UNIT

# How to Use / How to Install

## 1 Connecting to the Indoor Unit

1. Connect to the connector CN32 on the indoor controller board.
2. Press the connector for the remote ON/OFF adaptor into the CN32 connector.  
The connector can only be connected in one direction only. Do not force the connection.

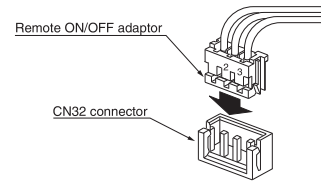

## 2 Locally Procured Wiring

With the remote ON/OFF adaptor, variations of connection method with the locally installed circuit will provide different types of operating configurations.

Example: External timer operation, remote control operation

### 1. Basic Connection Method

SW1 - Operating switch

Performs operation/stopping of indoor unit.

SW2 - Selecting switch

For selecting whether the operation/stopping is to be performed by external circuit or remote control.\*

\* Also includes system controller (central controller).

### 2. Switch Settings (Refer to table at right for details.)

SW2 - If on.

- Operation/stopping cannot be controlled from remote controller.
- Other operations (such as temperature settings and changing fan speed) can be performed.
- Operation/stopping can be performed by SW1.

SW2 - If off.

- Operations can be performed from remote controller.
- Operation/stopping cannot be performed by SW1.

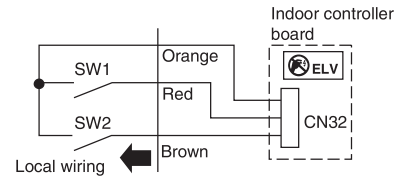

		SW2	
		ON	OFF
Remote controller	ON	Cannot perform operation/stopping	Can perform operation/stopping
	OFF	Operation	Cannot perform operation/stopping

## 3 Examples of Usage

In either case, there is a 5 to 6 second delay from the time when the operating command is sent until the unit operates.

1. To perform operation/stopping by only remote operation or external timer and to prohibit operation/stopping by the remote controller, use the following circuits.

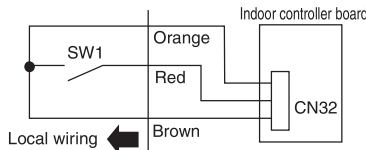

For remote operation

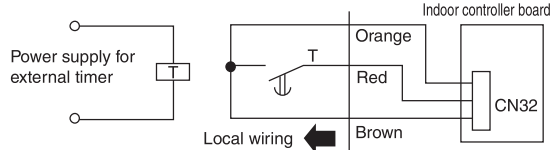

For remote timer operation

2. To perform operation/stopping by remote operation or external timer and allow operation/stopping by the remote controller, use the following circuits.

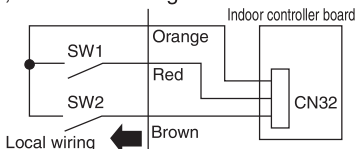

For remote operation

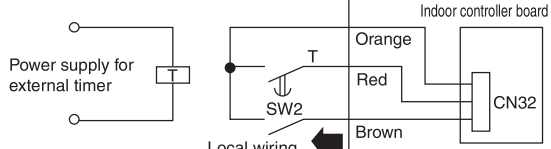

For remote timer operation

3. To start operation by remote operation and then freely use remote controller, use the following circuit.

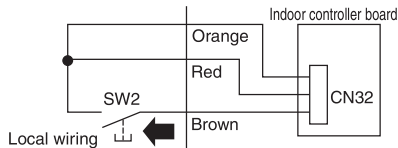

Use a momentary switch (a switch that is turned on manually and turns off automatically) for SW2. Press SW2 (for 1 second or more) and the operation starts. After this, the remote controller can be used for operations.

4. To permit/prohibit the use of the remote controller by an external circuit.

Since this is not used, be sure to completely wrap with insulation tape

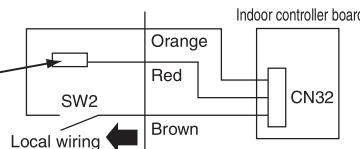

If SW2 is on, operation cannot be performed by the remote controller. If SW2 is off, operation is permitted.

## 4 Wiring Restrictions

Keep the length of wire from the circuit board of the indoor unit within 10 meters. Excessive length could cause improper operation. Use a transit relay when extending wiring such as remote wiring.

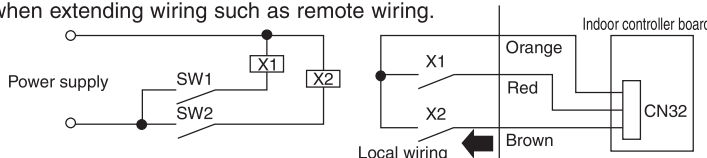

OPTIONAL PARTS

INDOOR UNIT