

# Modbus RTU (EIA-485) Interface for Mitsubishi Electric air conditioners

Compatible with Domestic, Mr. Slim and City Multi lines commercialized by  
Mitsubishi Electric

## USER MANUAL

Issue date: 11/2024 r2.8 ENGLISH



## Modbus RTU (EIA-485) Interface for Mitsubishi Electric air conditioners

Compatible with Domestic, Mr. Slim and City Multi lines commercialized by Mitsubishi Electric

<b>ORDER CODE</b>	<b>LEGACY ORDER CODE</b>
INMBSMIT001I000	ME-AC-MBS-1

## Important User Information

### Disclaimer

The information in this document is for informational purposes only. Please inform HMS Industrial Networks of any inaccuracies or omissions found in this document. HMS Industrial Networks disclaims any responsibility or liability for any errors that may appear in this document.

HMS Industrial Networks reserves the right to modify its products in line with its policy of continuous product development. The information in this document shall therefore not be construed as a commitment on the part of HMS Industrial Networks and is subject to change without notice. HMS Industrial Networks makes no commitment to update or keep current the information in this document.

The data, examples and illustrations found in this document are included for illustrative purposes and are only intended to help improve understanding of the functionality and handling of the product. In view of the wide range of possible applications of the product, and because of the many variables and requirements associated with any particular implementation, HMS Industrial Networks cannot assume responsibility or liability for actual use based on the data, examples or illustrations included in this document nor for any damages incurred during installation of the product. Those responsible for the use of the product must acquire sufficient knowledge in order to ensure that the product is used correctly in their specific application and that the application meets all performance and safety requirements including any applicable laws, regulations, codes and standards. Further, HMS Industrial Networks will under no circumstances assume liability or responsibility for any problems that may arise as a result from the use of undocumented features or functional side effects found outside the documented scope of the product. The effects caused by any direct or indirect use of such aspects of the product are undefined and may include e.g. compatibility issues and stability issues.

**INDEX**

1.	Presentation .....	5
2.	Connection .....	6
2.1	Connect to the AC indoor unit .....	6
2.2	Connection to the EIA-485 bus .....	6
3.	Quick Start Guide.....	7
4.	Modbus Interface Specification .....	8
4.1	Modbus physical layer.....	8
4.2	Modbus Registers.....	8
4.2.1	Control and status registers .....	8
4.2.2	Configuration Registers.....	10
4.2.3	Considerations on Temperature Registers .....	11
4.3	DIP-switch Configuration Interface .....	13
4.4	Implemented Functions .....	16
4.5	Device LED indicator .....	16
4.6	EIA-485 bus. Termination resistors and Fail-Safe Biasing mechanism .....	16
5.	Electrical and Mechanical features .....	17
6.	List of supported AC Unit Types. ....	18
7.	Error Codes .....	19

# 1. Presentation



The INMBSMIT001I000 interfaces allow a complete and natural integration of **Mitsubishi Electric** air conditioners into Modbus RTU (EIA-485) networks.

Compatible with all models of Domestic and Mr.Slim line. Check the section 5 for more information.

Reduced dimensions. 93 x 53 x 58 mm // 3.7" x 2.1" x 2.3"

- Quick and easy installation.  
*Mountable on DIN rail, wall, or even inside the indoor unit on some models of AC.*
- External power not required.
- Direct connection to Modbus RTU (EIA-485) networks. Up to 63 INMBSMIT001I000 devices can be connected on the same network.  
*INMBSMIT001I000 is a Modbus slave device.*
- Direct connection to the AC indoor unit. Up to 1 AC indoor units can be connected to INMBSMIT001I000. *The cable for this connection is also supplied.*
- Configuration from both on-board DIP-switches and Modbus RTU.
- Total Control and Supervision.
- Real states of the AC unit's internal variables.
- Allows simultaneous use of the AC's remote controls and Modbus RTU.

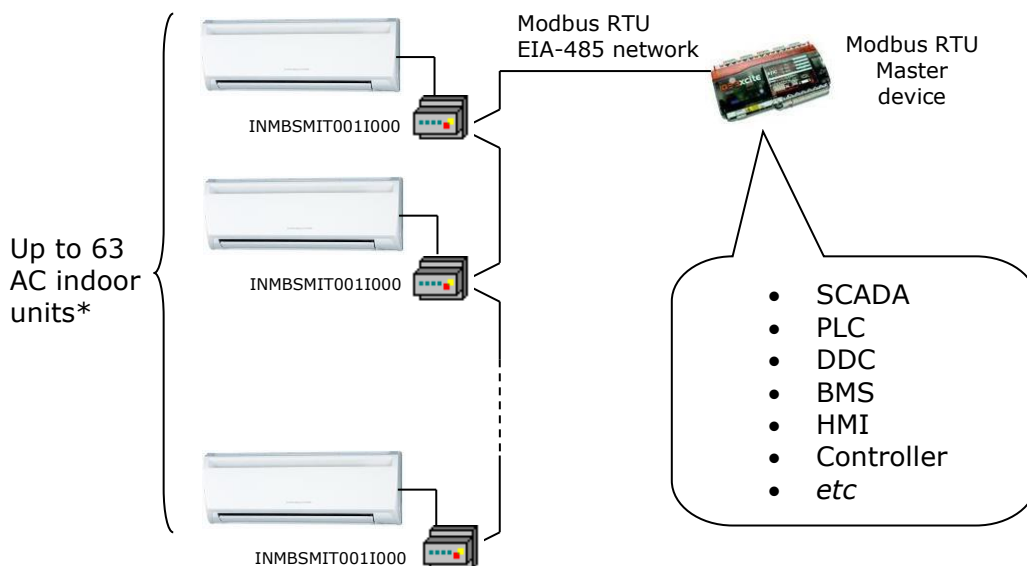

\* Up to 63 Intesis devices can be installed in the same Modbus RTU bus. However, the installation of Modbus Repeaters may be required.

## 2. Connection

The interface comes with a specific cable and connectors to establish direct connection with the AC indoor unit. It comes as well with a plug-in terminal block of 2 poles to establish direct connection with the Modbus RTU EIA-485 network.

### 2.1 Connect to the AC indoor unit

To connect the INMBSMIT001I000 interface with the AC indoor unit you must follow these steps:

Disconnect Mains Power from the AC unit. Open the front cover of the indoor unit to have access to the electronic circuit. Once you arrive at the electronic circuit, locate the socket connector marked as **CN105**.

Take the cable that comes with the interface, insert one of its connectors (the one installed in the shortest uncovered part) into the socket of the INMBSMIT001I000, and the other connector (the one installed in the largest uncovered part) to the socket **CN105** of the AC unit's electronic circuit. You can place the INMBSMIT001I000 inside or outside the AC indoor unit depending on your needs. Remember that the INMBSMIT001I000 must also be connected to the Modbus RTU EIA-485 network. Close the AC indoor unit's front cover again to finish the connection.

The cable supplied with the interface is 1.5 m (4.9 ft) long. Do not modify its length since it may affect the correct interface's operation. Keep the cable away from power and ground wires, and never bundle them together.

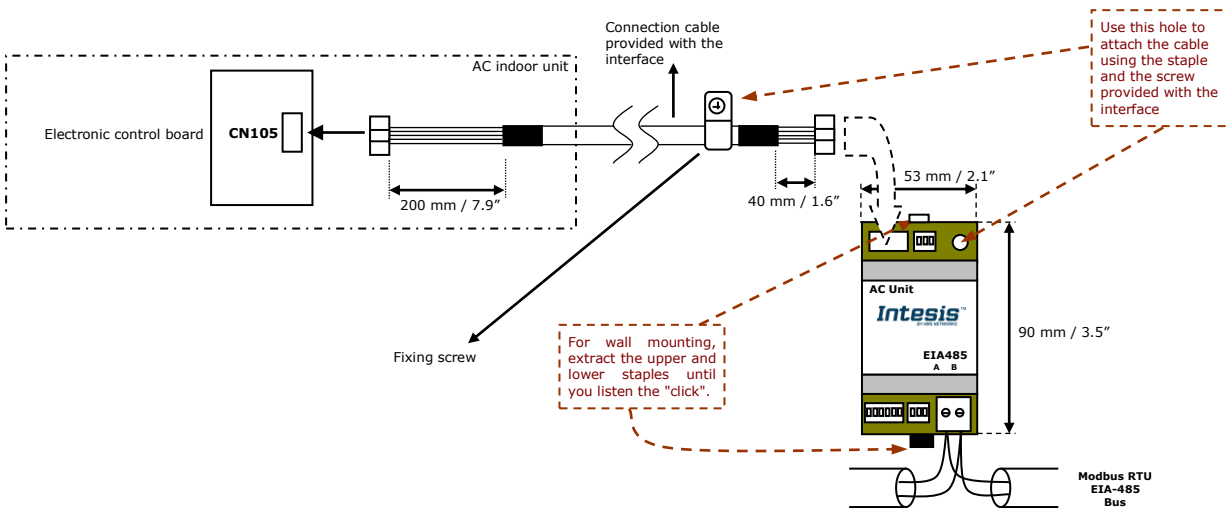

### 2.2 Connection to the EIA-485 bus

Connect the EIA-485 bus wires to the plug-in terminal block of INMBSMIT001I000 (the one with two poles) and keep the polarity on this connection (A+ and B-). Make sure that the maximum distance to the bus is 1,200 meters (3,937 ft). Loop or star typologies are not allowed in the case of the EIA-485 bus. A terminator resistor of 120Ω must be present at each end of the bus to avoid signal reflections. The bus needs a fail-safe biasing mechanism (see section 3.6 for more details).

## Quick Start Guide

1. Disconnect the air conditioning from the Mains Power.
2. Attach the interface next to the AC indoor unit (wall mounting) following the instructions of the diagram below or install it inside the AC indoor unit (respect the safety instructions given above and by the AC unit manufacturer).
3. Connect the connection cable included with the interface between the interface and the AC indoor unit following the instructions of the diagram.
4. Connect the EIA-485 bus to the interface's *EIA485* connector.
5. Close the AC indoor unit.
6. Check the DIP-Switch configuration of the Intesis interface and make sure it matches the current installation's parameters (see section 3.3).

By default, the interface is set to:

- Modbus Slave Address → 1
- Modbus baud rate → 9600 bps



These parameters can be modified from SW4 and SW3 DIP-Switches.

All other switch positions are set at low level (Off position ) by default.

**NOTE:** All changes on the DIP-Switch configuration require a system power cycle to be applied.

7. Connect the AC system to Mains Power.

**IMPORTANT:** The Intesis interface requires to be connected to the AC unit (powered) to start communicating.

### 3. Modbus Interface Specification

#### 3.1 Modbus physical layer

INMBSMIT001I000 implements a Modbus RTU (Slave) interface, to be connected to an EIA-485 line. It performs 8N2 communication (8 data bits, no parity and 2 stop bit) with several available baud rates (2400 bps, 4800 bps, 9600 bps -default-, 19200 bps, 38400 bps, 57600 bps, 76800 bps and 115200 bps). It also supports 8N1 communication (8 data bits, no parity and 1 stop bit).

**NOTE:** The gateway automatically detects the communication type (8N2 or 8N1) and sets itself accordingly. No action is needed.

#### 3.2 Modbus Registers

All registers are type "16-bit unsigned Holding Register" and they use the standard *Modbus big endian* notation.

##### 3.2.1 Control and status registers

Register Address (protocol address)	Register Address (PLC address)	R/W	Description
0	1	R/W	AC unit On/Off <ul style="list-style-type: none"> <li>▪ 0:Off</li> <li>▪ 1:On</li> </ul>
1	2	R/W	AC unit Mode <sup>1</sup> <ul style="list-style-type: none"> <li>▪ 0:Auto</li> <li>▪ 1:Heat</li> <li>▪ 2:Dry</li> <li>▪ 3:Fan</li> <li>▪ 4:Cool</li> </ul>
2	3	R/W	AC unit Fan Speed <sup>1</sup> <ul style="list-style-type: none"> <li>▪ 0:Auto</li> <li>▪ 1:Low</li> <li>▪ 2:Mid-1</li> <li>▪ 3:Mid-2</li> <li>▪ 4:High</li> </ul>
3	4	R/W	AC unit Vane Position <sup>1</sup> <ul style="list-style-type: none"> <li>▪ 0:Auto</li> <li>▪ 1:Horizontal</li> <li>▪ 2:Position-2</li> <li>▪ 3:Position-3</li> <li>▪ 4:Position-4</li> <li>▪ 5: Vertical</li> <li>▪ 10: Swing</li> </ul>
4	5	R/W	AC unit Temperature Setpoint <sup>1,2,3</sup> <ul style="list-style-type: none"> <li>▪ -32678 (Initialization value)</li> <li>▪ 16..32°C (°C/x10°C)</li> <li>▪ 61..90°F</li> </ul>
5	6	R	AC unit Temperature reference <sup>1,2,3</sup> <ul style="list-style-type: none"> <li>▪ -32678 (Initialization value)</li> <li>▪ 10..38°C (°C/x10°C)</li> <li>▪ 50..100°F</li> </ul>

<sup>1</sup> Available values will depend on the AC unit mode. Check the AC unit model functions in its User's Manual to know the possible values for this register.

<sup>2</sup> Magnitude for this register can be adjusted to Celsius x 1°C, Celsius x 10°C (Default) or Fahrenheit. See section 3.2.3 for more information.

<sup>3</sup> It is not possible turn to x10 the value shown in Fahrenheit.



Register Address (protocol address)	Register Address (PLC address)	R/W	Description
6	7	R/W	Window Contact <ul style="list-style-type: none"> <li>0: Closed (Default)</li> <li>1: Open</li> </ul>
7	8	R/W	INMBSMIT001I000 Disablement <sup>4</sup> <ul style="list-style-type: none"> <li>0: INMBSMIT001I000 enabled (Default)</li> <li>1: INMBSMIT001I000 disabled</li> </ul>
8	9	R/W	AC Remote Control Disablement <sup>4</sup> <ul style="list-style-type: none"> <li>0: Remote Control enabled (Default)</li> <li>1: Remote Control disabled</li> </ul>
9	10	R/W	AC unit Operation Time <sup>4</sup> <ul style="list-style-type: none"> <li>0..65535 (hours). Counts the time the AC unit is in "On" state.</li> </ul>
10	11	R	AC unit Alarm Status <ul style="list-style-type: none"> <li>0: No alarm condition</li> <li>1: Alarm condition</li> </ul>
11	12	R	Error Code <sup>5</sup> <ul style="list-style-type: none"> <li>0: No error present</li> <li>65535 (-1 if it is read as signed value): Error in the communication of INMBSMIT001I000 with the AC unit.</li> <li>Any other error present, see the table at the end of this document.</li> </ul>
22	23	R/W	Indoor unit's ambient temperature from external sensor (at Modbus side) <sup>1,2,3,6</sup> <ul style="list-style-type: none"> <li>-32768: (Initialization value). No temperature is being provided from an external sensor.</li> <li>Any other: (°C/x10°C/°F)</li> </ul>
23	24	R	AC Real setpoint temperature <sup>1,2,3,6</sup> <ul style="list-style-type: none"> <li>When no external temperature is provided, this read-only register will have the same value as register 5 (PLC address). In all cases, it will show the current setpoint in the indoor unit.</li> <li>16..32°C (°C/x10°C)</li> <li>60..90°F</li> </ul>
97	98	R/W	Block Periodic Sendings <sup>4,7,8</sup> <ul style="list-style-type: none"> <li>0: Non-blocked (Default value)</li> <li>1: Blocked</li> </ul>

<sup>4</sup> This value is stored in non-volatile memory

<sup>5</sup> See section 7 for possible error codes and their explanation

<sup>6</sup> See section 3.2.3 for more information

<sup>7</sup> If the register is configured as "0:Non-blocked", all commands received from Modbus will be sent to the AC system. If "1: Blocked", commands from Modbus will only be sent to the AC system if they differ from the previous value

<sup>8</sup> This register applies to firmware version 2.1 onwards

## 3.2.2 Configuration Registers

Register Address (protocol address)	Register Address (PLC address)	R/W	Description
13	14	R/W	"Open Window" switch-off timeout <sup>9</sup> <ul style="list-style-type: none"> <li>▪ 0..30 (minutes)</li> <li>▪ Factory setting: 30 (minutes)</li> </ul>
14	15	R	Modbus RTU baud-rate <ul style="list-style-type: none"> <li>▪ 2400bps</li> <li>▪ 4800bps</li> <li>▪ 9600bps (Default)</li> <li>▪ 19200bps</li> <li>▪ 38400bps</li> <li>▪ 57600bps</li> <li>▪ 76800bps</li> <li>▪ 115200bps</li> </ul>
15	16	R	Device's Modbus Slave address <ul style="list-style-type: none"> <li>▪ 1..63</li> </ul>
21	22	R	Max number of fan speeds <ul style="list-style-type: none"> <li>▪ Value depending on position of SW1-P4</li> </ul>
49	50	R	Device ID: 0x0500
50	51	R	Software version

<sup>9</sup> Once window contact is open, a count-down to switch off the AC Unit will start from this configured value.

### 3.2.3 Considerations on Temperature Registers

- **AC unit temperature setpoint (R/W)**  
(register 4 – in Protocol address / register 5 – in PLC address):  
This is the adjustable temperature setpoint value that must be required by the User. This register can be read (Modbus function 3 or 4) or written (Modbus functions 6 or 16). A Remote Controller connected to the Mitsubishi indoor unit will report the same temperature setpoint value as this register. This will apply when no AC unit's external reference temperature is provided from INMBSMIT001I000 (see details for register 22/23 below).
- **AC unit temperature reference (R)**  
(register 5 – in Protocol address / register 6 – in PLC address):  
This register reports the temperature that is currently used by the Mitsubishi indoor unit as the reference of its own control loop. Depending on the configuration of the indoor unit, this value can be the temperature reported by the sensor on the return path of the Mitsubishi indoor unit or the sensor of its Remote Controller. It is a read-only register (Modbus functions 3 or 4).
- **AC unit external temperature reference (Modbus) (R/W)**  
(register 22 – in Protocol address / register 23 – in PLC address):  
This register allows us to provide an external temperature's sensor from the Modbus side. Mitsubishi indoor unit does not allow, on devices like INMBSMIT001I000, to provide directly a temperature to be used as a reference of the control loop of the AC indoor unit. In order to overcome this limitation and enable the usage of an external temperature sensor (e.g. from Modbus side), INMBSMIT001I000 applies the following mechanism (only if "external temperature's reference" is being used):
  - After a couple of values have been entered in the "AC unit external temperature's reference" (register 22/23) and the "AC unit temperature set point" (register 4/5), INMBSMIT001I000 calculates the corresponding temperature's demand (e.g., if a "temperature setpoint (register 4/5)" of **22°C**, and an "external temperature reference (register 22/23)" of **20°C** are entered, INMBSMIT001I000 will assume that the user is demanding a **+2°C** increase in temperature).
  - By knowing at any time the ambient temperature currently used by the indoor unit to control its own operation (register 5/6), INMBSMIT001I000 can calculate the required temperature setpoint needed to apply the decrease/increase on the real temperature and reach the temperature chosen by the user (following the example above, if INMBSMIT001I000 reads an "ambient temperature" (register 5/6) of **24°C** in the indoor unit, it will apply a final setpoint of **24°C + 2°C = 26°C**).
  - At this moment, each time that INMBSMIT001I000 detects a change on the ambient temperature reported by the indoor unit (register 5/6), it will also change the required setpoint, in order to keep the temperature required by the user at any time. If we follow the last example, when INMBSMIT001I000 receives a new temperature's value coming from the indoor unit of **25°C**, INMBSMIT001I000 will automatically adjust the temperature setpoint required of the AC indoor unit to **25°C + 2°C = 27°C**).

- In general, INMBSMIT001I000 is constantly applying the "Virtual Temperature" formula:

$$S_{AC} = S_u - (T_u - T_{AC})$$

Where:

- $S_{AC}$  - setpoint value currently applied to the indoor unit
- $S_u$  - setpoint value written at Modbus side (register 4/5)
- $T_u$  - external temperature reference written at Modbus side (register 22/23)
- $T_{AC}$  - ambient temperature that the indoor unit is using as the reference of its own control loop (register 5/6)

When INMBSMIT001I000 detects a change in any of the values of  $\{ S_u, T_u, T_{AC} \}$ , it will send the new setpoint ( $S_{AC}$ ) to the indoor unit.

- After the startup, the value for "external temperature's reference" (register 22/23) has a value -32768 (0x8000). This value means that no external temperature reference is being provided through INMBSMIT001I000. In this scenario, the setpoint value shown or written in register 4/5 will always be the same as the current setpoint value of the indoor unit.
- Notice that, the use of the "external temperature reference" (register 22/23) (e.g., writing a value different from -32768 / 0x8000 in it) has the following relevant consequences:
  - The mechanism of "Virtual Temperature" is applied. The temperature setpoint's value shown by the Remote Controller or other Control System from Mitsubishi connected to the indoor unit may show a different value from the value shown in register 4/5.
  - The User is not be able to change the setpoint using any Remote Controller from Mitsubishi, as setpoint of the indoor unit becomes exclusively controlled by the "Virtual Temperature" mechanism.
- **AC Real setpoint temperature (R)**

(register 23 – In Protocol address / register 24 – in PLC address):

As it has been detailed on the previous point, the real temperature setpoint in the indoor unit and the temperature setpoint requested from INMBSMIT001I000 might differ (when a value in register 22/23 – "external temperature reference" is entered). This register always informs about the current temperature setpoint which is being used by the indoor unit – it also includes the temperature setpoint that will be shown by an additional remote controller from Mitsubishi connected to the indoor unit, if it is present on the system.

Moreover, notice that temperature's values of all these four registers are expressed according to the temperature's format configured through its onboard DIP-Switches (See 3.3). The following formats are possible:

- **Celsius value:** Value in Modbus register is the temperature value in Celsius (i.e. a value "22" in the Modbus register must be interpreted as 22°C).
- **Decicelsius value:** Value in Modbus register is the temperature value in decicelsius (i.e. a value "220" in the Modbus register must be interpreted as 22.0°C).
- **Fahrenheit value:** Value in Modbus register is the temperature value in Fahrenheit (i.e. a value "72" in the Modbus register must be interpreted as 72°F (~22°C)).

### 3.3 DIP-switch Configuration Interface

All the configuration values on INMBSMIT001I000 can be written and read from Modbus interface. Otherwise, some of them can also be setup from its on-board DIP-switch interface. The device has DIP-switches SW1, SW3 and SW4 on the following locations:

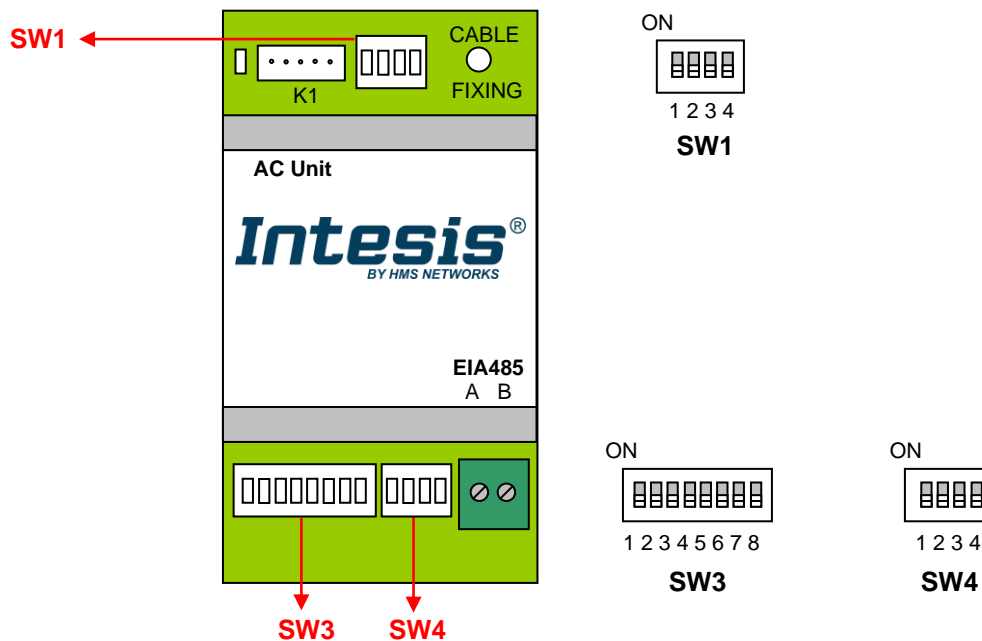















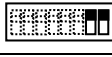

The following tables apply to the interface's configuration through DIP-switches:

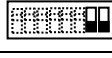
#### SW1 – AC indoor unit's features: fan speed & vanes

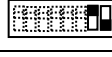
SW1-P1..4	Description
	AC indoor Unit has 4 fan speeds and AUTO (Default value)
	AC indoor Unit has 4 fan speeds
	AC indoor Unit has 3 fan speeds and AUTO
	AC indoor Unit has 3 fan speeds
	Not defined
	AC Indoor Unit has 2 fan speeds
	Not defined
	Not defined
	AC Indoor Unit has 3 or 4 fan speeds, with or without fan-auto (Default value).
	AC Indoor Unit has 2 fan speeds, without fan-auto

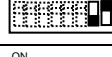

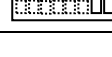



**Table 4.1** SW1: AC indoor unit's features

**SW3/SW4** – Baud rate configuration

SW3-P7..8	SW4-P3	Description
		2400bps
		4800bps
		9600bps (Default value)
		19200bps
		38400bps
		57600bps
		76800bps
		115200bps

**Table 4.2** SW3-SW4: Modbus baud rate

**SW4** – Degrees/Decidegrees (x10), temperature magnitude (°C/°F) and EIA-485 termination resistor.

SW4-P1..2-4	Description
	Temperature values in Modbus register are represented in degrees (x1) (Default value)
	Temperature values in Modbus register are represented in decidegrees (x10)
	Temperature values in Modbus register are represented in Celsius degrees (Default value)
	Temperature values in Modbus register are represented in Fahrenheit degrees
	EIA-485 bus without termination resistor (Default value)
	Internal termination resistor of 120Ω connected to EIA-485 bus

**Table 4.3** SW4: Temperature and termination resistor configuration

**SW3** – Modbus Slave address

Add	SW3-P1..6	Add	SW3-P1..6	Add	SW3-P1..6	Add	SW3-P1..6	Add	SW3-P1..6
0		13		26		39		52	
1		14		27		40		53	
2		15		28		41		54	
3		16		29		42		55	
4		17		30		43		56	
5		18		31		44		57	
6		19		32		45		58	
7		20		33		46		59	
8		21		34		47		60	
9		22		35		48		61	
10		23		36		49		62	
11		24		37		50		63	
12		25		38		51			

**Table 4.4** SW3: Modbus slave address

### 3.4 Implemented Functions

INMBSMIT001I000 implements the following standard Modbus functions:

- 3: Read Holding Registers
- 4: Read Input Registers
- 6: Write Single Register
- 16: Write Multiple Registers (Despite this function is allowed, the interface does not allow to write operations on more than 1 register with the same request, this means that length field should be always be 1 when this function is being used in case of writing)

### 3.5 Device LED indicator

The device includes a LED indicator to show all the possible operational states. In the following table, there is a description for each indication.

Device status	LED indication	ON / OFF Period	Description
On power-up	LED pulse	ON for 5 seconds / OFF after	Device reset / power-up
During normal operation	LED flashing	200ms ON / 2s OFF	Device correctly configured and working
During normal operation	LED OFF	OFF continuously	No Modbus Slave address configured
During normal operation	LED blinking	200ms ON / 200ms OFF	Communication Error with the AC unit

### 3.6 EIA-485 bus. Termination resistors and Fail-Safe Biasing mechanism

EIA-485 bus requires a 120Ω terminator resistor at each end of the bus to avoid signal reflections.

In order to prevent fail status detected by the receivers, which are "*listening*" the bus, when all the transmitters' outputs are in three-state (high impedance), it is also required a fail-safe biasing mechanism. This mechanism provides a safe status (a correct voltage level) in the bus when all the transmitters' outputs are in three-state. This mechanism must be supplied by the Modbus master.

The INMBSMIT001I000 device includes an on-board terminator resistor of 120Ω that can be connected to the EIA-485 bus by using DIP-switch SW4.

Some Modbus RTU EIA-485 Master devices can provide also internal 120Ω terminator resistor and/or fail-safe biasing mechanism (check the technical documentation of the Master device connected to the EIA-485 network in each case).



### 4. Electrical and Mechanical features

Enclosure	Plastic, type PC (UL 94 V-0) Net dimensions (dxwxh): 93 x 53 x 58 mm / 3.7" x 2.1" x 2.3" Color: Light Grey. RAL 7035	Operation Temperature	0°C to +60°C
Weight	85 g.	Stock Temperature	-20°C to +85°C
Mounting	Wall DIN rail EN60715 TH35.	Operational Humidity	<95% RH, non-condensing
Terminal Wiring (for low-voltage signals)	For terminal: solid wires or stranded wires (twisted or with ferrule) 1 core: 0.5mm <sup>2</sup> ... 2.5mm <sup>2</sup> 2 cores: 0.5mm <sup>2</sup> ... 1.5mm <sup>2</sup> 3 cores: not permitted	Stock Humidity	<95% RH, non-condensing
Modbus RTU port	1 x Serial EIA485 Plug-in screw terminal block (2 poles): A, B Compatible with Modbus RTU EIA-485 networks	Isolation voltage	1500 VDC
AC unit port	1 x Specific connector Specific cable included	Isolation resistance	1000 MΩ
Switch 1 (SW1)	1 x DIP-Switch for AC features	Protection	IP20
Switch 3 (SW3)	1 x DIP-Switch for Modbus RTU settings	LED indicators	1 x Onboard LED - Operational status
Switch 4 (SW4)	1 x DIP-Switch for extra functions		

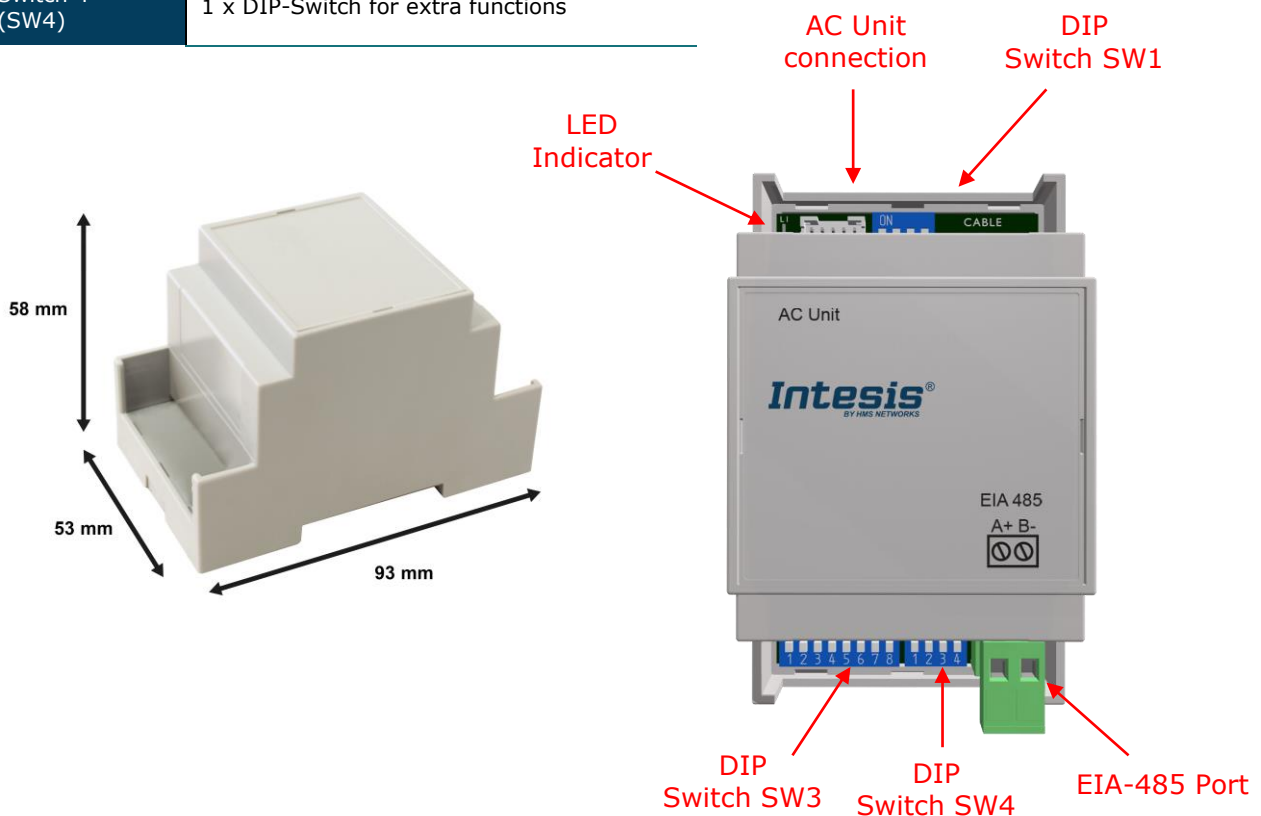

## ***5. List of supported AC Unit Types.***

A list of Mitsubishi Electric indoor unit model's references compatible with INMBSMIT001I000 and its available features can be found on this link:

[https://www.intesis.com/docs/compatibilities/inxxxmit001ix00\\_compatibility](https://www.intesis.com/docs/compatibilities/inxxxmit001ix00_compatibility)

## 6. Error Codes

Error Code	Description
0	No active error
1102	Discharge Temperature high
1108	Internal thermostat detector working (49C)
1110	Outdoor unit fail
1300	Pressure low
1302	Pressure high (High pressure probe working 63H)
1503	Protection against freeze or battery high temperature
1504	Protection against freeze or battery high temperature
1504	Overheating protection
1509	High pressure error (ball valve closed)
1520	Super heating anomaly due to low temp. of discharge. (TH4)
2500	Erroneous operation of drain pump
2502	Erroneous operation of drain pump
2503	Drain sensor anomaly (DS)
4030	Serial transmission error
4100	Compressor pause due to excess of current (initial block)
4101	Compressor pause due to excess of current (overload)
4102	Phase detection opened
4103	Anti-phase detection
4108	Phase opened in phase L2 or connector 51CM opened
4118	Error in the anti-phase detector (electronic board)
4124	Connector 49L opened
4210	Cut due to over-current of compressor
4220	Voltage anomaly
4230	Radiator panel temperature anomaly (TH8)
5101	Ambient temperature probe anomaly (TH1), indoor unit
5102	Liquid probe anomaly (TH2)
5102	Cond/Evap probe anomaly (TH5)
5104	Error detection in discharge temperature
5105	Outdoor probe error TH3
5106	Outdoor probe error TH7
5107	Outdoor probe error TH6
5110	Outdoor probe error TH8
5202	Connector 63L opened
5300	Current probe error
6600	MNET duplicated address definition
6602	MNET Line transmission hardware error
6603	MNET BUS busy
6606	MNET Line transmission error
6607	MNET transmission error
6607	MNET without ack
6608	MNET transmission error
6608	MNET without response
6831	AC's remote command transmission error (reception error)
6832	AC's remote command transmission error (transmission error)
6840	Transmission error with the indoor/outdoor unit (reception error)
6841	Transmission error with the indoor/outdoor unit (transmission error)
6844	Error in inter-connection cable in the indoor/outdoor unit, indoor unit number deactivated (5 min or more)
6845	Error in inter-connection cable in the indoor/outdoor unit (cabling error, disconnection)
6846	Initial timer deactivated
65535 (-1)	Error in the communication of INMBSMIT001I000 with the AC Unit

In case to detect an error code not listed, contact your closest Mitsubishi Electric technical support service.