

# 1. Product Specifications

## 1-2. External Dimensions

QAHV-N560YA-HPB(-BS)

Unit: mm

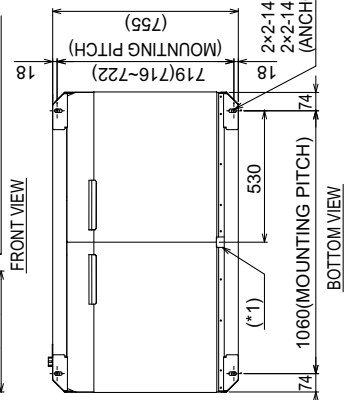
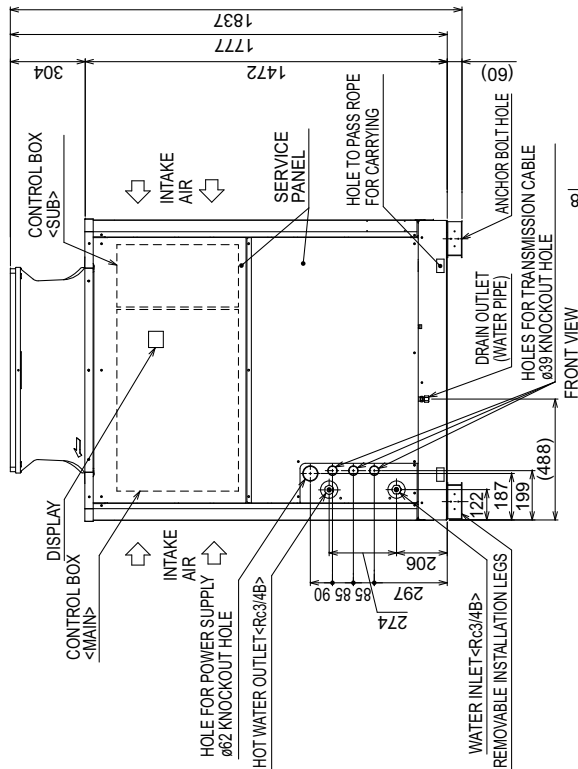
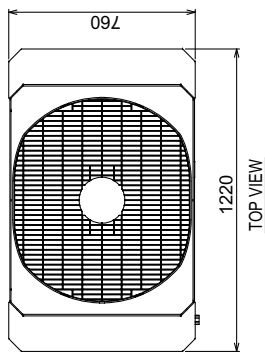
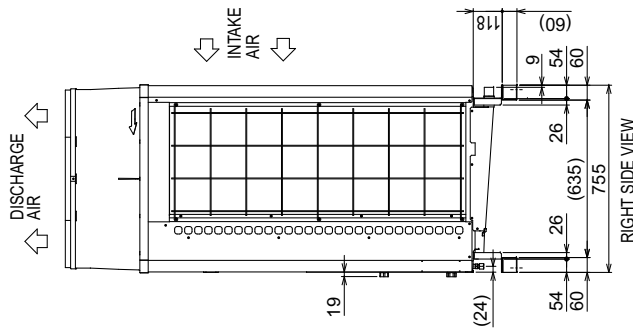
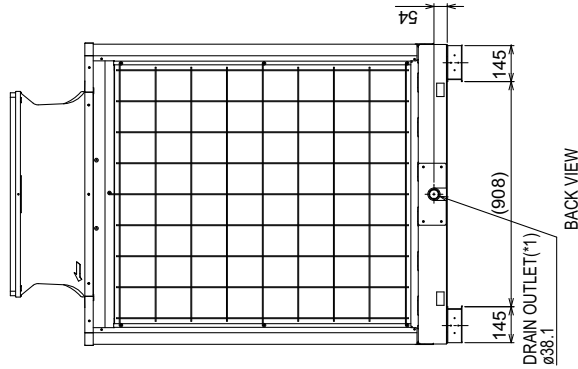
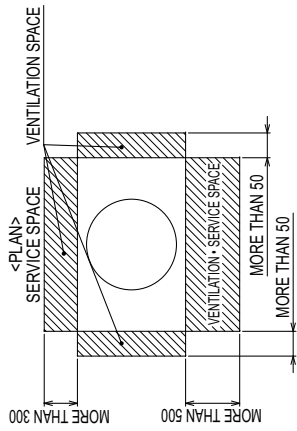

The specification of the product is for the improvement a previous notice and might change.

# 1. Product Specifications

## 1-3. Center of Gravity

QAHV-N560YA-HPB(-BS)

Unit: mm

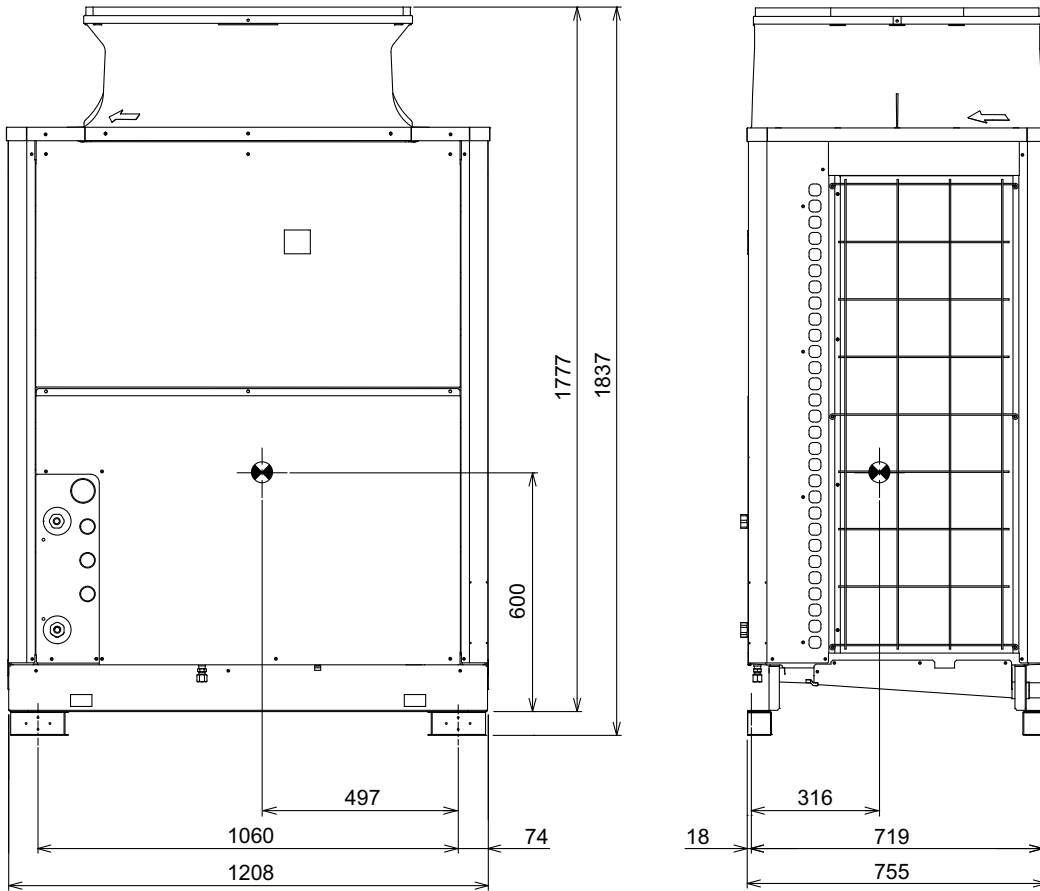

QAHV-N-YA-HPB