

# TECHNICAL & SERVICE MANUAL

## Series PKFY Wall Mounted R410A

Indoor unit

[Model Name]

[Service Ref.]

PKFY-P10VLM-E  
PKFY-P10VLM-ET

PKFY-P10VLM-ER1.TH  
PKFY-P10VLM-ETR1.TH

PKFY-P15VLM-E  
PKFY-P15VLM-ET

PKFY-P15VLM-ER1.TH  
PKFY-P15VLM-ETR1.TH

PKFY-P20VLM-E  
PKFY-P20VLM-ET

PKFY-P20VLM-ER1.TH  
PKFY-P20VLM-ETR1.TH

PKFY-P25VLM-E  
PKFY-P25VLM-ET

PKFY-P25VLM-ER1.TH  
PKFY-P25VLM-ETR1.TH

PKFY-P32VLM-E  
PKFY-P32VLM-ET

PKFY-P32VLM-ER1.TH  
PKFY-P32VLM-ETR1.TH

PKFY-P40VLM-E  
PKFY-P40VLM-ET

PKFY-P40VLM-ER1.TH  
PKFY-P40VLM-ETR1.TH

PKFY-P50VLM-E  
PKFY-P50VLM-ET

PKFY-P50VLM-ER1.TH  
PKFY-P50VLM-ETR1.TH

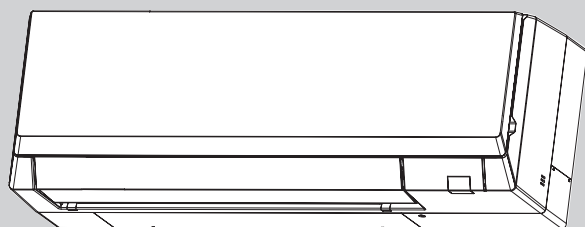

INDOOR UNIT

Model name  
indication

### CONTENTS

1. SAFETY PRECAUTION.....	2
2. PARTS NAMES AND FUNCTIONS.....	4
3. SPECIFICATION .....	13
4. NOISE CRITERION CURVES.....	16
5. OUTLINES AND DIMENSIONS.....	18
6. WIRING DIAGRAM .....	20
7. REFRIGERANT SYSTEM DIAGRAM.....	21
8. TROUBLESHOOTING .....	21
9. DISASSEMBLY PROCEDURE .....	29

PARTS CATALOG (TCB071)

# CITY MULTI

## Cautions for units utilizing refrigerant R410A

**Do not use the existing refrigerant piping.**

The old refrigerant and lubricant in the existing piping contains a large amount of chlorine which may cause the lubricant deterioration of the new unit.

**Use “low residual oil piping”**

If there is a large amount of residual oil (hydraulic oil, etc.) inside the piping and joints, deterioration of the lubricant will result.

**Store the piping indoors, and both ends of the piping sealed until just before brazing. (Leave elbow joints, etc. in their packaging.)**

If dirt, dust or moisture enters into refrigerant cycle, that can cause deterioration of refrigerant oil or malfunction of compressor.

**The refrigerant oil applied to flare and flange connections must be ester oil, ether oil or alkylbenzene oil in a small amount.**

If large amount of mineral oil enters, that can cause deterioration of refrigerant oil etc.

**Charge refrigerant from liquid phase of gas cylinder.**

If the refrigerant is charged from gas phase, composition change may occur in refrigerant and the efficiency will be lowered.

**Do not use refrigerant other than R410A.**

If other refrigerant (R22, etc.) is used, chlorine in refrigerant can cause deterioration of refrigerant oil, etc.

**Use a vacuum pump with a reverse flow check valve.**

Vacuum pump oil may flow back into refrigerant cycle and that can cause deterioration of refrigerant oil, etc.

**Use the following tools specifically designed for use with R410A refrigerant.**

The following tools are necessary to use R410A refrigerant.

Tools for R410A	
Gauge manifold	Flare tool
Charge hose	Size adjustment gauge
Gas leak detector	Vacuum pump adaptor
Torque wrench	Electronic refrigerant charging scale

**Handle tools with care.**

If dirt, dust or moisture enters into refrigerant cycle, that can cause deterioration of refrigerant oil or malfunction of compressor.

**Do not use a charging cylinder.**

If a charging cylinder is used, the composition of refrigerant will change and the efficiency will be lowered.

**Use the specified refrigerant only.****Never use any refrigerant other than that specified.**

Doing so may cause a burst, an explosion, or fire when the unit is being used, serviced, or disposed of.

Correct refrigerant is specified in the manuals and on the spec labels provided with our products.

We will not be held responsible for mechanical failure, system malfunction, unit breakdown or accidents caused by failure to follow the instructions.

**Ventilate the room if refrigerant leaks during operation. If refrigerant comes into contact with a flame, poisonous gases will be released.**

### [1] Cautions for service

- (1) Perform service after collecting the refrigerant left in the unit completely.
- (2) Do not release refrigerant in the air.
- (3) After completing service, charge the cycle with specified amount of refrigerant.
- (4) When performing service, install a filter drier simultaneously.  
Be sure to use a filter drier for new refrigerant.

### [2] Additional refrigerant charge

#### When charging directly from cylinder

- (1) Check that cylinder for R410A on the market is syphon type.
- (2) Charging should be performed with the cylinder of syphon stood vertically. (Refrigerant is charged from liquid phase.)

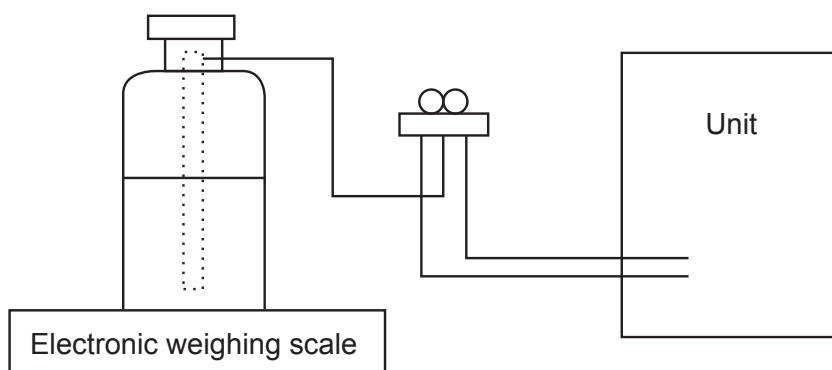

### [3] Service tools

Use the below service tools as exclusive tools for R410A refrigerant.

No.	Tool name	Specifications
①	Gauge manifold	<ul style="list-style-type: none"> <li>· Only for R410A</li> <li>· Use the existing fitting specifications. (UNF1/2)</li> <li>· Use high-tension side pressure of 5.3 MPa·G or over.</li> </ul>
②	Charge hose	<ul style="list-style-type: none"> <li>· Only for R410A</li> <li>· Use pressure performance of 5.09 MPa·G or over.</li> </ul>
③	Electronic weighing scale	—
④	Gas leak detector	· Use the detector for R134a, R407C or R410A.
⑤	Adaptor for reverse flow check	· Attach on vacuum pump.
⑥	Refrigerant charge base	—
⑦	Refrigerant cylinder	<ul style="list-style-type: none"> <li>· Only for R410A</li> <li>Top of cylinder (Pink)</li> <li>Cylinder with syphon</li> </ul>
⑧	Refrigerant recovery equipment	—

## 2

# PARTS NAMES AND FUNCTIONS

### 2-1. Indoor unit

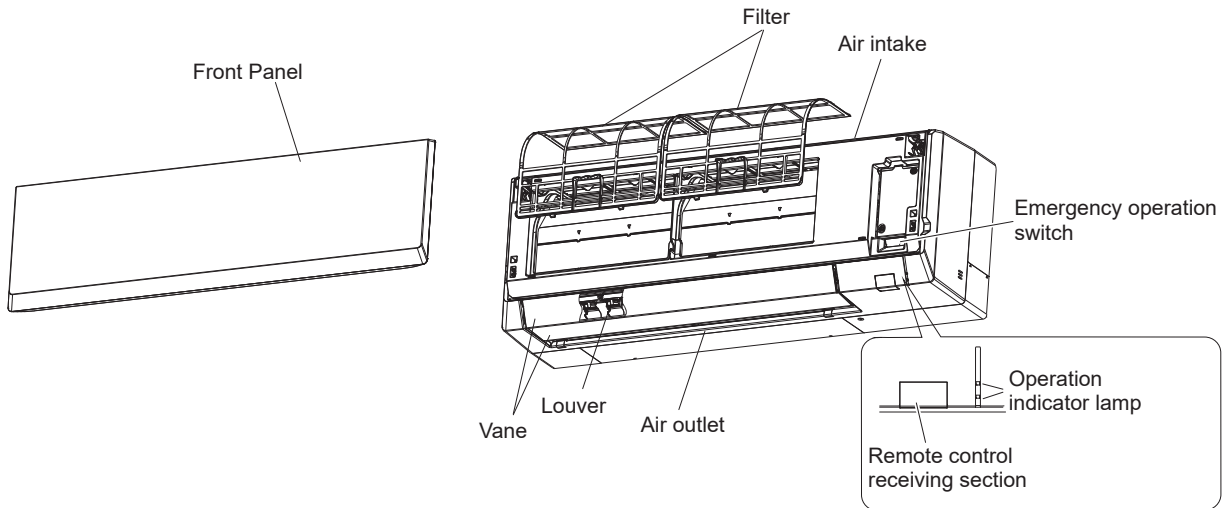

### 2-2. Wired Remote Controller <PAR-41MAA> <PAR-21MAA>

#### Wired remote controller function

The functions which can be used are restricted according to each model.

○ : Supported ✕ : Unsupported

	Function	PAR-41MAA		PAR-21MAA
		Slim	CITY MULTI	
Body	Product size H × W × D (mm)	120 × 120 × 14.5		120 × 130 × 19
	LCD	Full Dot LCD		Partial Dot LCD
	Backlight	○		✕
Energy saving	Energy saving operation schedule	○	✕	✕
	Automatic return to the preset temperature	○		✕
Restriction	Setting the temperature range restriction	○		○
Function*	Operation lock function	○		○
	Weekly timer	○		✕
	ON/OFF timer	○		○
	High Power	○	✕	✕
	Manual vane angle	○		○

\*Some functions may not be available depending on model types.

## Controller interface

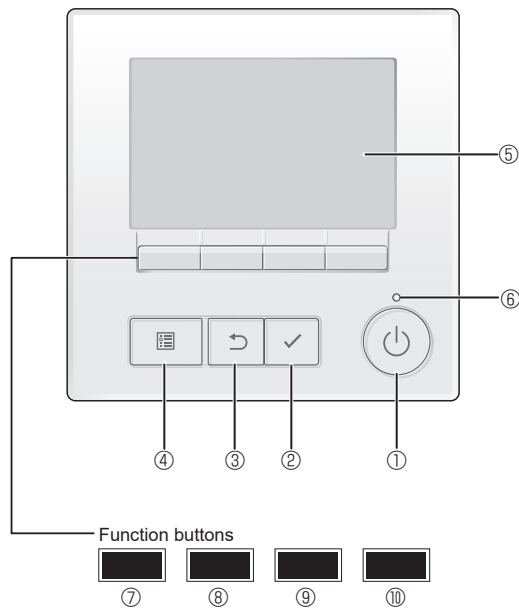

### ① [ON/OFF] button

Press to turn ON/OFF the indoor unit.

### ② [SELECT] button

Press to save the setting.

### ③ [RETURN] button

Press to return to the previous screen.

### ④ [MENU] button

Press to bring up the Main menu.

### ⑤ Backlit LCD

Operation settings will appear.

When the backlight is off, pressing any button turns the backlight on and it will stay lit for a certain period of time depending on the screen.

When the backlight is off, pressing any button turns the backlight on and does not perform its function. (except for the [ON/OFF] button)

The functions of the function buttons change depending on the screen.

Refer to the button function guide that appears at the bottom of the LCD for the functions they serve on a given screen.

When the system is centrally controlled, the button function guide that corresponds to the locked button will not appear.

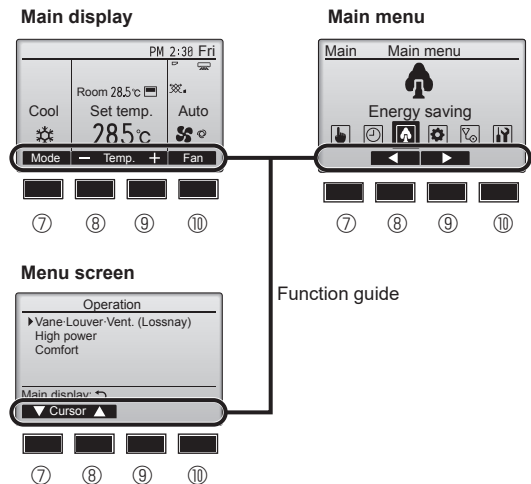

### ⑥ ON/OFF lamp

This lamp lights up in green while the unit is in operation. It blinks while the remote controller is starting up or when there is an error.

### ⑦ Function button [F1]

Main display: Press to change the operation mode.

Menu screen: The button function varies with the screen.

### ⑧ Function button [F2]

Main display: Press to decrease temperature.

Main menu: Press to move the cursor left.

Menu screen: The button function varies with the screen.

### ⑨ Function button [F3]

Main display: Press to increase temperature.

Main menu: Press to move the cursor right.

Menu screen: The button function varies with the screen.

### ⑩ Function button [F4]

Main display: Press to change the fan speed.

Menu screen: The button function varies with the screen.

## Display

The main display can be displayed in two different modes: "Full" and "Basic". The factory setting is "Full". To switch to the "Basic" mode, change the setting on the Main display setting. (Refer to operation manual included with remote controller.)

<Full mode>

\* All icons are displayed for explanation.

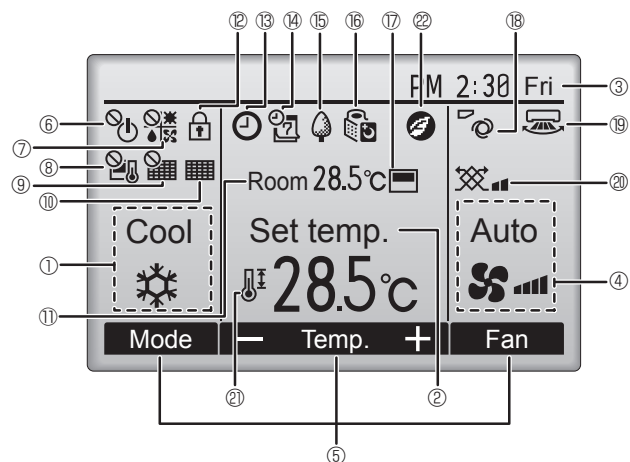

<Basic mode>

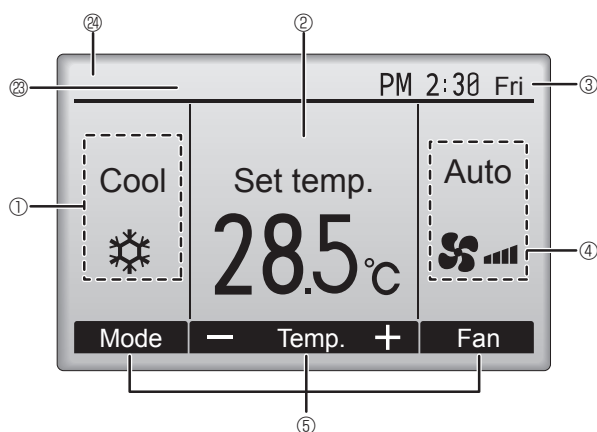

### ① Operation mode

### ② Preset temperature

### ③ Clock

Current time appears here.

### ④ Fan speed

### ⑤ Button function guide

Functions of the corresponding buttons appear here.



Appears when the ON/OFF operation is centrally controlled.



Appears when the operation mode is centrally controlled.



Appears when the preset temperature is centrally controlled.



Appears when the filter reset function is centrally controlled.



Indicates when filter needs maintenance.

### ⑪ Room temperature

Current room temperature appears here.



Appears when the buttons are locked.



Appears when the On/Off timer, Night setback, or Auto-off timer function is enabled.

 appears when the timer is disabled by the centralized control system.



Appears when the Weekly timer is enabled.



Appears while the units are operated in the energy-save mode. (Will not appear on some models of indoor units)



Appears while the outdoor units are operated in the silent mode. (This indication is not available for CITY MULTI models.)



Appears when the built-in thermistor on the remote controller is activated to monitor the room temperature (⑪).



 appears when the thermistor on the indoor unit is activated to monitor the room temperature.



Indicates the vane setting.



Indicates the louver setting.



Indicates the ventilation setting.



Appears when the preset temperature range is restricted.



Appears when an energy-saving operation is performed using a "3D i-See sensor" function. (not available)

### ⑳ Centrally controlled

Appears for a certain period of time when a centrally-controlled item is operated.

### ㉔ Preliminary error display

An error code appears during the preliminary error.

Most settings (except ON/OFF, mode, fan speed, temperature) can be made from the Main menu. (Refer to Page 10.)

## Menu structure

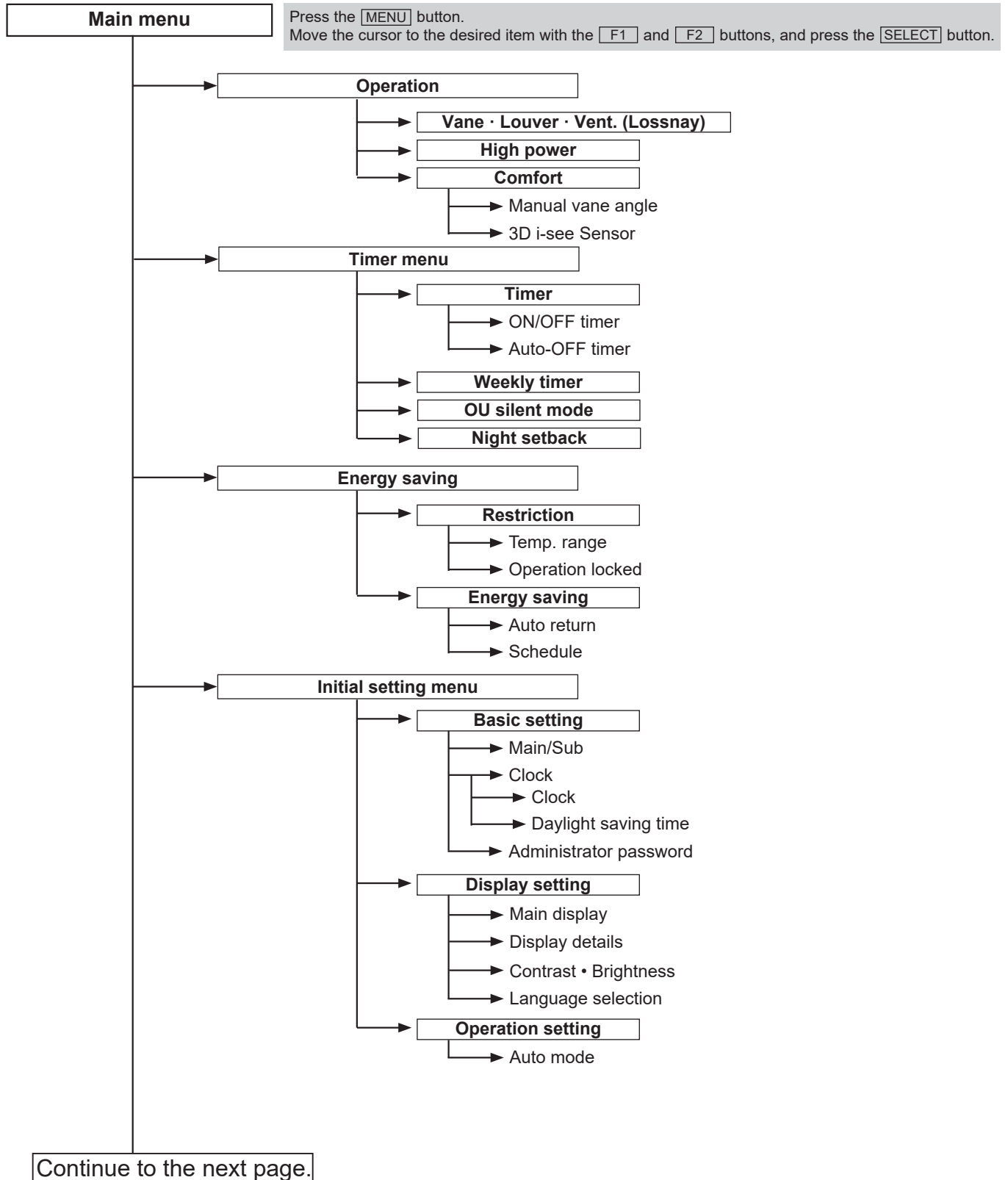

Not all functions are available on all models of indoor units.

Continue from the previous page.

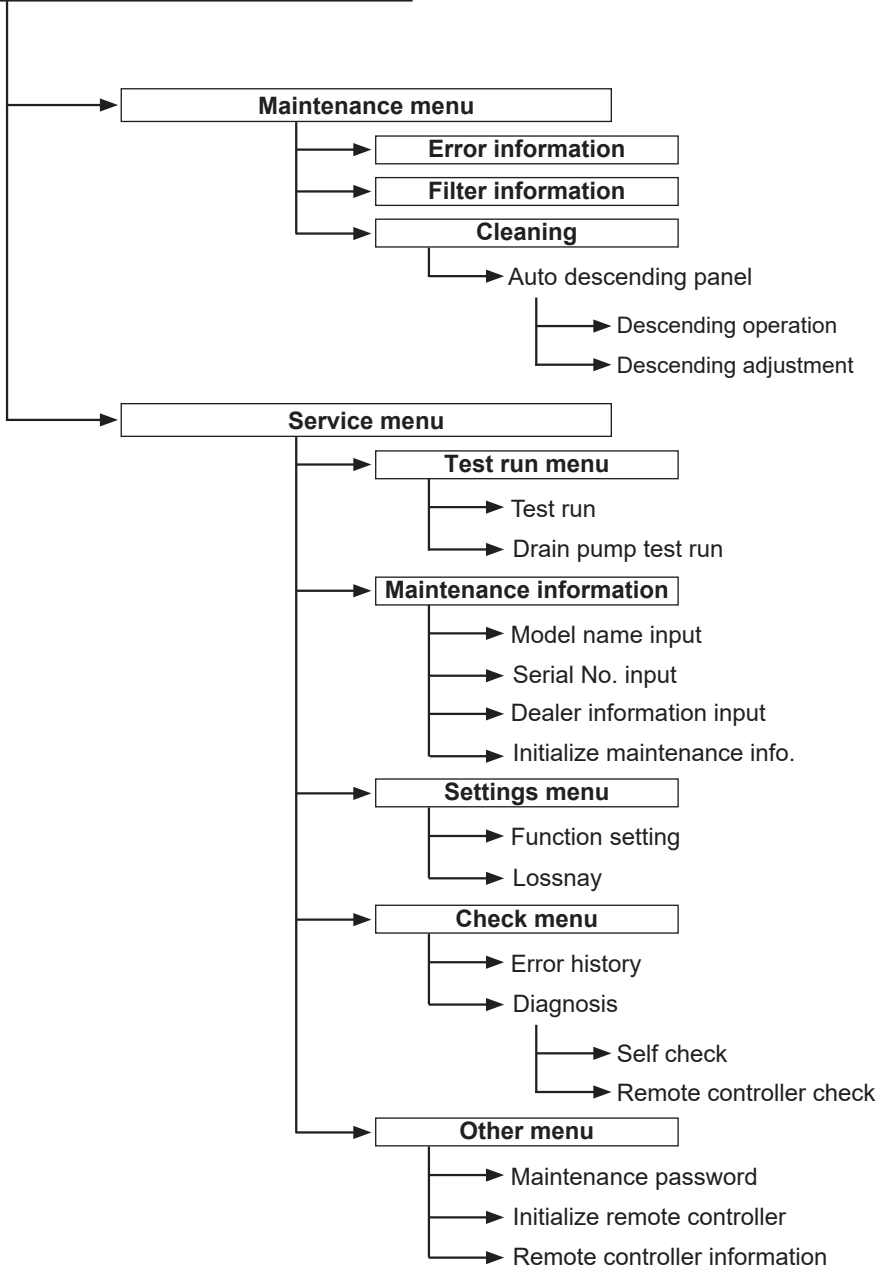

Not all functions are available on all models of indoor units.



## Main menu list

Main menu	Setting and display items		Setting details
Operation	Vane · Louver · Vent. (Lossnay)		<p><b>Use to set the vane angle.</b></p> <ul style="list-style-type: none"> <li>• Select a desired vane setting from 5 different settings.</li> </ul> <p><b>Use to turn ON/OFF the louver.</b></p> <ul style="list-style-type: none"> <li>• Select a desired setting from "ON" and "OFF."</li> </ul> <p><b>Use to set the amount of ventilation.</b></p> <ul style="list-style-type: none"> <li>• Select a desired setting from "Off," "Low," and "High."</li> </ul>
	High power		<p><b>Use to reach the comfortable room temperature quickly.</b></p> <ul style="list-style-type: none"> <li>• Units can be operated in the High-power mode for up to 30 minutes.</li> </ul>
	Comfort	Manual vane angle	<p><b>Use to fix each vane angle.</b></p>
		3D i-see Sensor	<p><b>Use to set the following functions for 3D i-see Sensor.</b></p> <ul style="list-style-type: none"> <li>• Air distribution</li> <li>• Energy saving option</li> <li>• Seasonal airflow</li> </ul>
Timer	Timer	ON/OFF timer *1	<p><b>Use to set the operation ON/OFF times.</b></p> <ul style="list-style-type: none"> <li>• Time can be set in 5-minute increments.</li> </ul>
		Auto-Off timer	<p><b>Use to set the Auto-Off time.</b></p> <ul style="list-style-type: none"> <li>• Time can be set to a value from 30 to 240 in 10-minute increments.</li> </ul>
	Weekly timer *1, *2		<p><b>Use to set the weekly operation ON/OFF times.</b></p> <ul style="list-style-type: none"> <li>• Up to 8 operation patterns can be set for each day. (Not valid when the ON/OFF timer is enabled.)</li> </ul>
	OU silent mode *1		<p><b>Use to set the time periods in which priority is given to quiet operation of outdoor units over temperature control. Set the Start/Stop times for each day of the week.</b></p> <ul style="list-style-type: none"> <li>• Select the desired silent level from "Normal," "Middle," and "Quiet."</li> </ul>
	Night setback *1		<p><b>Use to make Night setback settings.</b></p> <ul style="list-style-type: none"> <li>• Select "Yes" to enable the setting, and "No" to disable the setting. The temperature range and the start/stop times can be set.</li> </ul>
Energy saving	Restriction	Temp. range *2	<p><b>Use to restrict the preset temperature range.</b></p> <ul style="list-style-type: none"> <li>• Different temperature ranges can be set for different operation modes.</li> </ul>
		Operation lock	<p><b>Use to lock selected functions.</b></p> <ul style="list-style-type: none"> <li>• The locked functions cannot be operated.</li> </ul>
	Energy saving	Auto return *2	<p><b>Use to get the units to operate at the preset temperature after performing energy saving operation for a specified time period.</b></p> <ul style="list-style-type: none"> <li>• Time can be set to a value from 30 and 120 in 10-minute increments. (This function will not be valid when the preset temperature ranges are restricted.)</li> </ul>
		Schedule *1	<p><b>Set the start/stop times to operate the units in the energy saving mode for each day of the week, and set the energy saving rate.</b></p> <ul style="list-style-type: none"> <li>• Up to 4 energy saving operation patterns can be set for each day.</li> <li>• Time can be set in 5-minute increments.</li> <li>• Energy saving rate can be set to a value from 0% or 50 to 90% in 10% increments.</li> </ul>

\*1 Clock setting is required.

\*2 33.8°F (1°C) increments.

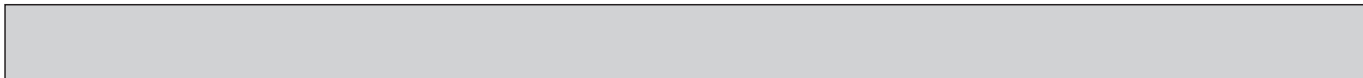

Main menu	Setting and display items		Setting details
Initial setting	Basic setting	Main/Sub	When connecting 2 remote controllers, one of them needs to be designated as a sub controller.
		Clock	Use to set the current time.
		Daylight saving time	Set the daylight saving time.
		Administrator password	The administrator password is required to make the settings for the following items. • Timer setting • Energy saving setting • Weekly timer setting • Restriction setting • Outdoor unit silent mode setting • Night set back
	Display setting	Main display	Use to switch between "Full" and "Basic" modes for the Main display. • The initial setting is "Full."
		Black and white inversion setting	Use to invert the colors of the display, turning white background to black and black characters to white.
		Display details	Make the settings for the remote controller related items as necessary. <b>Clock:</b> The initial settings are "Yes" and "24h" format. <b>Temperature:</b> Set either Celsius (°C) or Fahrenheit (°F). <b>Room temp. :</b> Set Show or Hide. <b>Auto mode:</b> Set the Auto mode display or Only Auto display.
		Contrast • Brightness	Use to adjust screen contrast and brightness.
		Language selection	Use to select the desired language.
	Operation setting	Auto mode	Whether or not to use the Auto mode can be selected by using the button. This setting is valid only when indoor units with the Auto mode function are connected.
Maintenance	Error information		Use to check error information when an error occurs. • Check code, error source, refrigerant address, unit model, manufacturing number, contact information (dealer's phone number) can be displayed. (The unit model, manufacturing number, and contact information need to be registered in advance to be displayed.)
	Filter information		Use to check the filter status. • The filter sign can be reset.
	Cleaning	Auto descending panel	Use to lift and lower the auto descending panel (Optional parts).
Service	Test run		Select "Test run" from the Service menu to bring up the Test run menu. • Test run • Drain pump test run
	Input maintenance		Select "Input maintenance Info." from the Service menu to bring up the Maintenance information screen. The following settings can be made from the Maintenance Information screen. • Model name input • Serial No. input • Dealer information input • Initialize maintenance info.
	Settings	Function setting	Make the settings for the indoor unit functions via the remote controller as necessary.
		LOSSNAY setting	This setting is required only when the operation of CITY MULTI units is interlocked with LOSSNAY units.
	Check	Error history	Display the error history and execute "delete error history".
		Diagnosis	<b>Self check:</b> Error history of each unit can be checked via the remote controller. <b>Remote controller check:</b> When the remote controller does not work properly, use the remote controller checking function to troubleshoot the problem.
	Other	Maintenance password	Use to change the maintenance password.
		Initialize remote controller	Use to initialize the remote controller to the factory shipment status.
remote controller information		Use to display the remote controller model name, software version, and serial number.	

# WIRED REMOTE CONTROLLER <PAR-21MAA>

## Display Section

For the purposes of explanation, all parts of the display are shown. During actual operation, only the relevant items will be lit.

**Identifies the current operation**  
Shows the operating mode, etc. Multilingual display is available.

**"Centrally Controlled" indicator**  
Indicates that operation from the remote controller has been prohibited by a master controller.

**"Timer is Off" indicator**  
Indicates that the timer is off.

**Temperature Setting**  
Shows the target temperature.

**Day-of-Week**  
Shows the current day of the week.

**Time/Timer Display**  
Shows the current time, unless the simple or Auto-off timer is set.  
If the simple or Auto-off timer is set, the time to be switched off is shown.

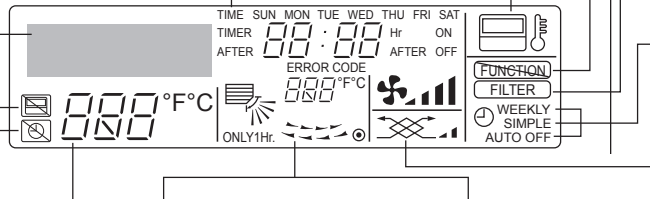

**"Sensor" indication**  
Displays when the remote controller sensor is used.

**"Locked" indicator**  
Indicates that remote controller buttons have been locked.

**"Clean The Filter" indicator**  
To be displayed on when it is time to clean the filter.

**Timer indicators**  
The indicator comes on if the corresponding timer is set.

**Fan Speed indicator**  
Shows the selected fan speed.

**Ventilation indicator**  
Appears when the unit is running in Ventilation mode.

**Up/Down Air Direction indicator**  
The indicator shows the direction of the outgoing airflow.

**Room Temperature display**  
Shows the room temperature. The room temperature display range is 8–39°C. The display blinks if the temperature is less than 8°C or 39°C or more.

**"One Hour Only" indicator**  
Displays if the airflow is set to Low or downward during COOL or DRY mode. (Operation varies according to model.)  
The indicator goes off in one hour, at which time the airflow direction also changes.

**Louver display**  
Indicates the action of the swing louver. Does not appear if the louver is not running.

**(Power On indicator)**  
Indicates that the power is on.

## Operation Section

Temperature setting buttons

- ▽ Down
- △ Up

Timer Menu button (Monitor/Set button)

Mode button (Return button)

Set Time buttons

- ▽ Back
- △ Ahead

Timer ON/OFF button (Set Day button)

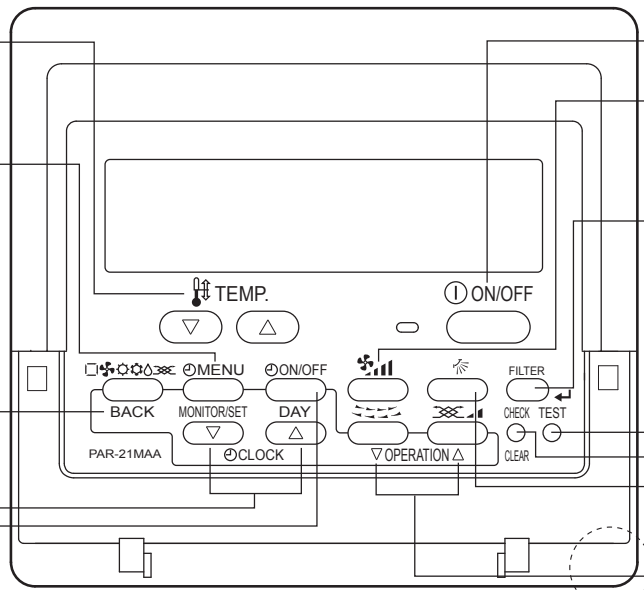
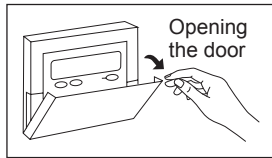

ON/OFF button

Fan Speed button

Filter button (<Enter> button)

Test Run button

Check button (Clear button)

Airflow Up/Down button

Louver button (▽ Operation button)  
▽ To return operation number

Ventilation button (△ Operation button)  
△ To go to next operation number

Built-in temperature sensor

**Note:**

- "PLEASE WAIT" message  
This message is displayed for approximately 3 minutes when power is supplied to the indoor unit or when the unit is recovering from a power failure.
- "NOT AVAILABLE" message  
This message is displayed if an invalid button is pressed (to operate a function that the indoor unit does not have).  
If a single remote controller is used to operate multiple indoor units simultaneously that are different types, this message will not be displayed as far as any of the indoor units is equipped with the function.

## 2-3. Wireless remote controller

### Controller interface

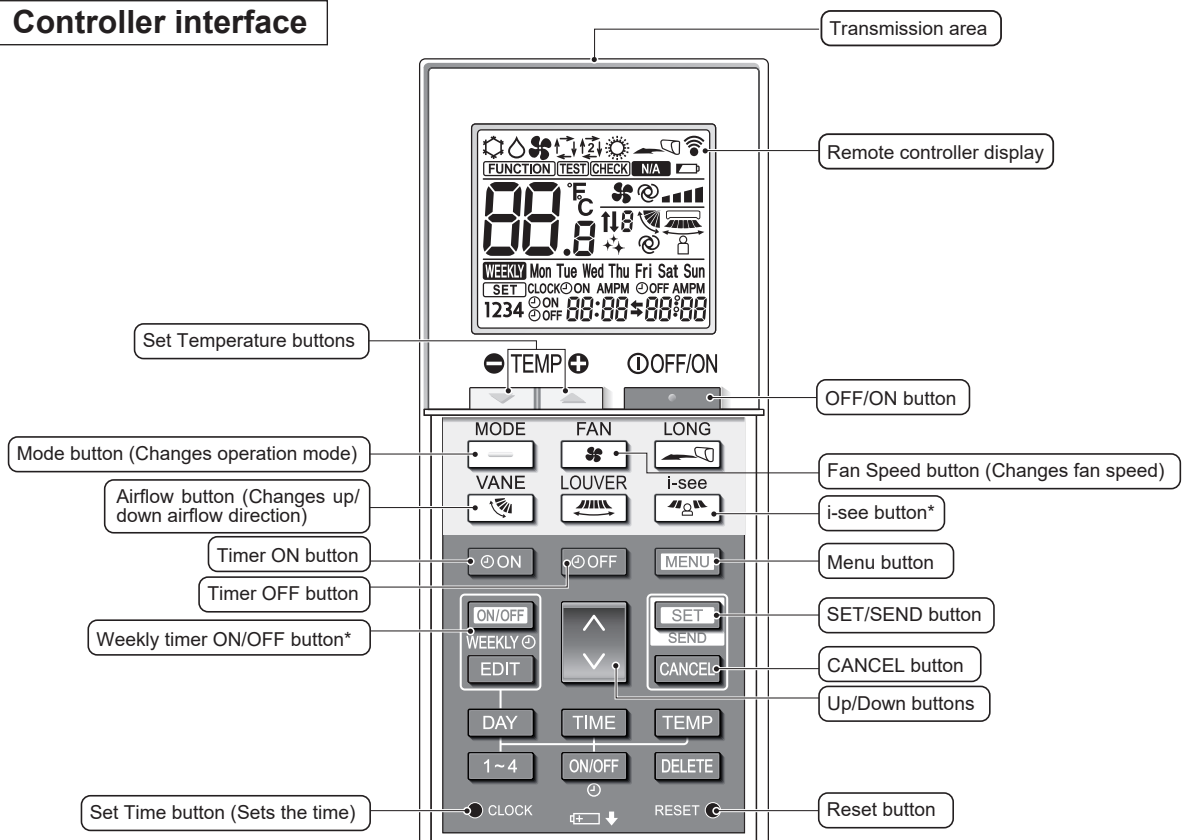

**Note:**

\* This button is enabled or disabled depending on the model of the indoor unit.

### Display

**Operation mode**

- Cool (snowflake icon)
- Dry (water drop icon)
- Fan (fan icon)
- Auto (single set point) (circular arrow icon)
- Heat (sun icon)
- Auto\* (dual set point) (circular arrow with two dots icon)

\* The initial setting is necessary. Refer to 4) in 3.2.

**Temperature setting**  
The units of temperature can be changed. For details, refer to the Installation Manual.

**Vane setting**

Step 1 Step 2 Step 3 Step 4 Step 5 Swing Auto

**Not available**  
Appears when a non-supported function is selected.

**Battery replacement indicator**  
Appears when the remaining battery power is low.

**Fan speed setting**

Auto

**3D i-see sensor (Air distribution)**

Default Direct Indirect

When Direct or Indirect is selected, the vane setting is set to "Auto".

## 3-1. SPECIFICATIONS

Model			PKFY-P10VLM-E PKFY-P10VLM-ET	PKFY-P15VLM-E PKFY-P15VLM-ET	PKFY-P20VLM-E PKFY-P20VLM-ET	PKFY-P25VLM-E PKFY-P25VLM-ET	
Power source			1-phase 220-240 V 50 Hz, 1-phase 220-230 V 60 Hz				
Cooling capacity (Nominal)	*1	kW	1.2	1.7	2.2	2.8	
	*1	kcal/h	1000	1500	1900	2400	
	*1	BTU/h	4100	5800	7500	9600	
		Power input	kW	0.02	0.02	0.02	0.03
		Current input	A	0.20	0.20	0.20	0.25
Heating capacity (Nominal)	*2	kW	1.4	1.9	2.5	3.2	
	*2	kcal/h	1200	1600	2200	2800	
	*2	BTU/h	4800	6500	8500	10900	
		Power input	kW	0.01	0.01	0.01	0.02
		Current input	A	0.15	0.15	0.15	0.20
External finish(Munsell No.)			Plastic (0.7PB 9.2/0.4)				
External dimension H x W x D		mm	299 × 773 × 237				
		inch	11-25/32 × 30-7/16 × 9-11/32				
Net weight		kg (lb)	11(25)				
Heat exchanger			Cross fin (Aluminum fin and copper tube)				
Fan	Type x Quantity		Line flow fan x 1				
	External static press	Pa (mmH2O)	0(0)				
	Motor type		DC motor				
	Motor output	kW	0.03				
	Driving mechanism		Direct driven				
	Airflow rate (Low-Mid2 -Mid1-High)	m <sup>3</sup> /min	3.3-3.5-3.8-4.2	4.0-4.2-4.4-4.7	4.0-4.4-4.9-5.4	4.0-4.6-5.4-6.7	
		L/s	55-58-63-70	67-70-73-78	67-73-82-90	67-77-90-112	
cfm		117-124-134-148	141-148-155-166	141-155-173-191	141-162-191-237		
Noise level (Low-Mid2-Mid1-High) (measured in anechoic room)		dB <A>	22-24-26-28	22-24-26-28	22-26-29-31	22-27-31-35	
Insulation material			Polyethylene sheet				
Air filter			PP Honeycomb				
Protection device			Fuse				
Refrigerant control device			LEV				
Connectable outdoor unit			R410A CITY MULTI				
Diameter of refrigerant pipe	Liquid	mm (in)	φ6.35 (φ1/4)				
	Gas	mm (in)	φ12.7 (φ1/2)				
Field drain pipe size		mm (in)	I.D.16 (5/8)				
Standard attachment			Installation Manual, Instruction Book				
Optional parts	DRAIN PUMP KIT		PAC-SK01DM-E				
	EXTERNAL LEV BOX		PAC-SK17LE-E	PAC-SG95LE-E			
Remark			Details on foundation work, duct work, insulation work, electrical wiring, power source switch, and other items shall be referred to the Installation Manual. Due to continuing improvement, above specifications may be subject to change without notice.				
Notes: *1.Nominal cooling conditions (subject to JIS B8615-1) Indoor: 27°C.D.B./19°C.W.B. (81°F.D.B./66°F.W.B.), Outdoor: 35°C.D.B. (95°F.D.B.) Pipe length: 7.5 m (24-9/16 ft), Level difference: 0 m (0 ft) *2.Nominal heating conditions (subject to JIS B8615-1) Indoor: 20°C.D.B. (68°F.D.B.), Outdoor: 7°C.D.B./6°C.W.B. (45°F.D.B./43°F.W.B.) Pipe length: 7.5 m (24-9/16 ft), Level difference: 0 m (0 ft)					Unit converter kcal/h = kW × 860 Btu/h = kW × 3,412 cfm = m <sup>3</sup> /min × 35.31 lb = kg/0.4536 Note: Above specification data is subject to rounding variation.		

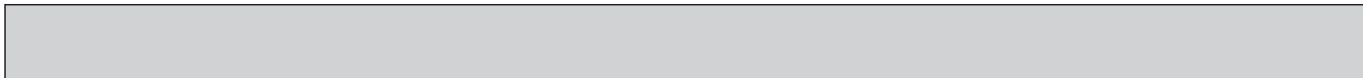

Model			PKFY-P32VLM-E PKFY-P32VLM-ET	PKFY-P40VLM-E PKFY-P40VLM-ET	PKFY-P50VLM-E PKFY-P50VLM-ET	
Power source			1-phase 220-240 V 50 Hz, 1-phase 220-230 V 60 Hz			
Cooling capacity (Nominal)	*1	kW	3.6	4.5	5.6	
	*1	kcal/h	3100	3900	4800	
	*1	BTU/h	12300	15400	19100	
		Power input	kW	0.04	0.04	0.05
		Current input	A	0.35	0.35	0.45
Heating capacity (Nominal)	*2	kW	4.0	5.0	6.3	
	*2	kcal/h	3400	4300	5400	
	*2	BTU/h	13600	17100	21500	
		Power input	kW	0.03	0.03	0.04
		Current input	A	0.30	0.30	0.40
External finish(Munsell No.)			Plastic (0.7PB 9.2/0.4)			
External dimension H x W x D		mm	299 x 773 x 237	299 x 898 x 237		
		inch	11-25/32 x 30-7/16 x 9-11/32	11-25/32 x 35-3/8 x 9-11/32		
Net weight		kg (lb)	11(25)	13(29)		
Heat exchanger			Cross fin (Aluminum fin and copper tube)			
Fan	Type x Quantity		Line flow fan x 1			
	External static press	Pa (mmH2O)	0(0)			
	Motor type		DC motor			
	Motor output	kW	0.03			
	Driving mechanism		Direct driven			
	Airflow rate (Low-Mid2 -Mid1-High)	m <sup>3</sup> /min	4.3-5.4-6.9-8.4	6.3-7.4-8.6-10.0	6.8-8.3-10.2-12.4	
		L/s	72-90-115-140	105-123-143-167	113-138-170-207	
cfm		152-191-244-297	222-261-304-353	240-293-360-438		
Noise level (Low-Mid2-Mid1-High) (measured in anechoic room)		dB <A>	24-31-37-41	29-34-37-40	31-36-41-46	
Insulation material			Polyethylene sheet			
Air filter			PP Honeycomb			
Protection device			Fuse			
Refrigerant control device			LEV			
Connectable outdoor unit			R410A CITY MULTI			
Diameter of refrigerant pipe	Liquid	mm (in)	φ6.35 (φ1/4)			
	Gas	mm (in)	φ12.7 (φ1/2)			
Field drain pipe size		mm (in)	I.D.16 (5/8)			
Standard attachment			Installation Manual, Instruction Book			
Optional parts	DRAIN PUMP KIT		PAC-SK01DM-E			
	EXTERNAL LEV BOX		PAC-SG95LE-E			
Remark			Details on foundation work, duct work, insulation work, electrical wiring, power source switch, and other items shall be referred to the Installation Manual. Due to continuing improvement, above specifications may be subject to change without notice.			
Notes: *1.Nominal cooling conditions (subject to JIS B8615-1) Indoor: 27°C.D.B./19°C.W.B. (81°F.D.B./66°F.W.B.), Outdoor: 35°C.D.B. (95°F.D.B.) Pipe length: 7.5 m (24-9/16 ft), Level difference: 0 m (0 ft) *2.Nominal heating conditions (subject to JIS B8615-1) Indoor: 20°C.D.B. (68°F.D.B.), Outdoor: 7°C.D.B./6°C.W.B. (45°F.D.B./43°F.W.B.) Pipe length: 7.5 m (24-9/16 ft), Level difference: 0 m (0 ft)						

### 3-2. ELECTRICAL PARTS SPECIFICATIONS

Service ref. Parts name	Symbol	PKFY-P10VLM-(ER1/ETR1).TH PKFY-P15VLM-(ER1/ETR1).TH PKFY-P20VLM-(ER1/ETR1).TH PKFY-P25VLM-(ER1/ETR1).TH	PKFY-P32VLM-(ER1/ETR1).TH PKFY-P40VLM-(ER1/ETR1).TH PKFY-P50VLM-(ER1/ETR1).TH
Room temperature detection thermistor	TH21	Resistance 0°C /15kΩ, 10°C /9.6kΩ, 20°C /6.3kΩ, 25°C /5.4kΩ, 30°C /4.3kΩ, 40°C /3.0kΩ	
Pipe temperature detection thermistor/liquid	TH22	Resistance 0°C /15kΩ, 10°C /9.6kΩ, 20°C /6.3kΩ, 25°C /5.4kΩ, 30°C /4.3kΩ, 40°C /3.0kΩ	
Pipe temperature detection thermistor/gas	TH23	Resistance 0°C /15kΩ, 10°C /9.6kΩ, 20°C /6.3kΩ, 25°C /5.4kΩ, 30°C /4.3kΩ, 40°C /3.0kΩ	
Fuse (Indoor controller board)	FUSE	T3.15AL250V	
Fan motor (with thermal fuse)	MF	8 X 30W / RC0J30-QD	
Vane motor (Upper)	MV1	MSFBC20 DC12V	
Vane motor (Lower)	MV2	NSEK302 DC12V	
Linear expansion valve	LEV	DC12V Stepping motor drive Port φ2.4(P10), φ2.63(P15/20/25/32/40/50) (0-2000pulse)	
Power supply terminal block	TB2	(L, N, ⊕) Rated to 250V 20A *	
Transmission terminal block	TB5	(M1, M2, S) Rated to 250V 20A *	
MA-Remote controller terminal block	TB15	(1, 2) Rated to 250V 10A *	

\* Refer to WIRING DIAGRAM for the supplied voltage.

NOISE CRITERION CURVES

PKFY-P10VLM-(E/ET)

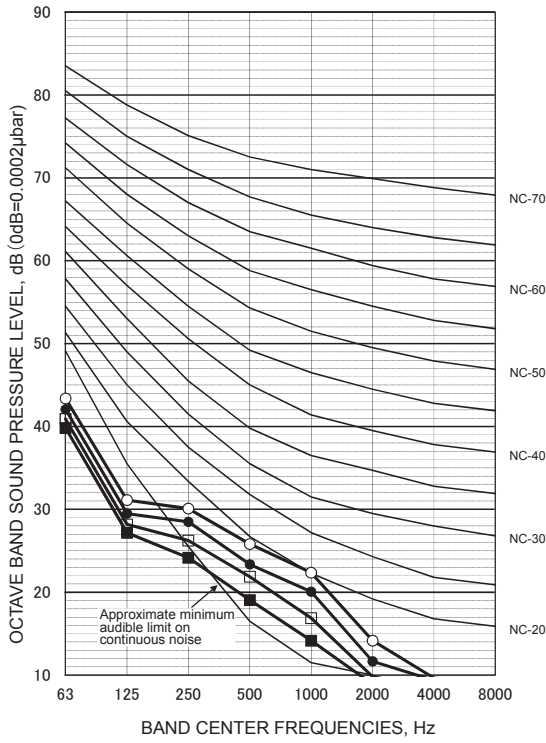

PKFY-P15VLM-(E/ET)

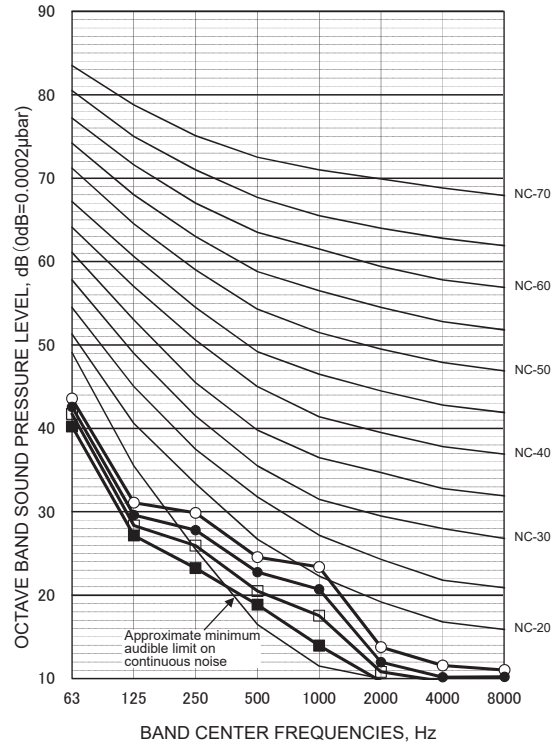

PKFY-P20VLM-(E/ET)

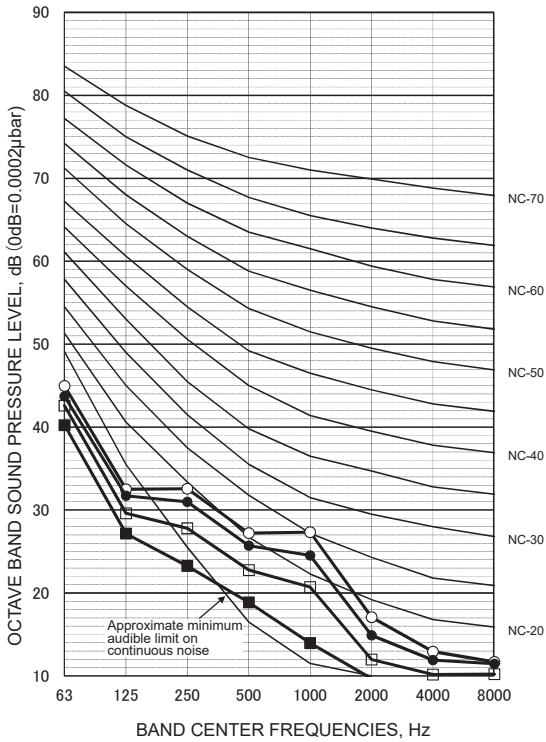

PKFY-P25VLM-(E/ET)

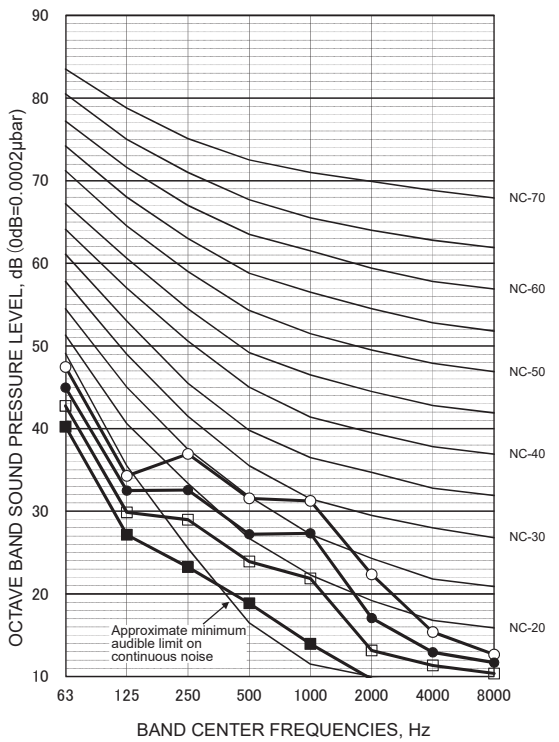



**PKFY-P32VLM-(E/ET)**

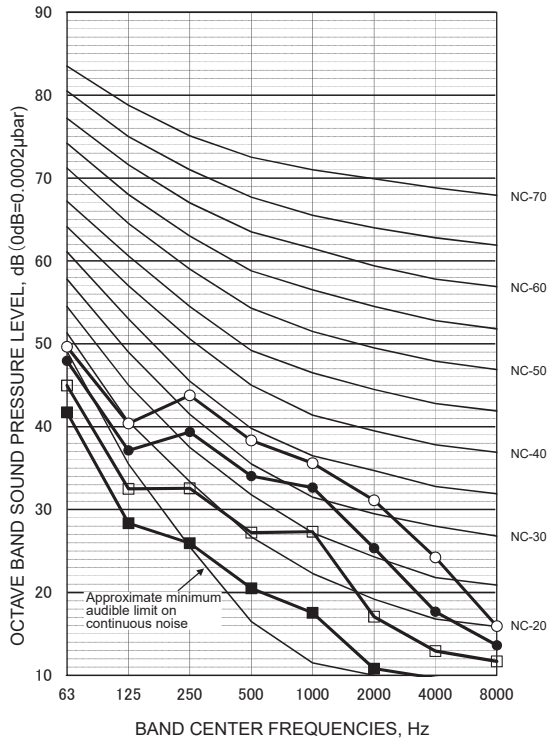

**PKFY-P40VLM-(E/ET)**

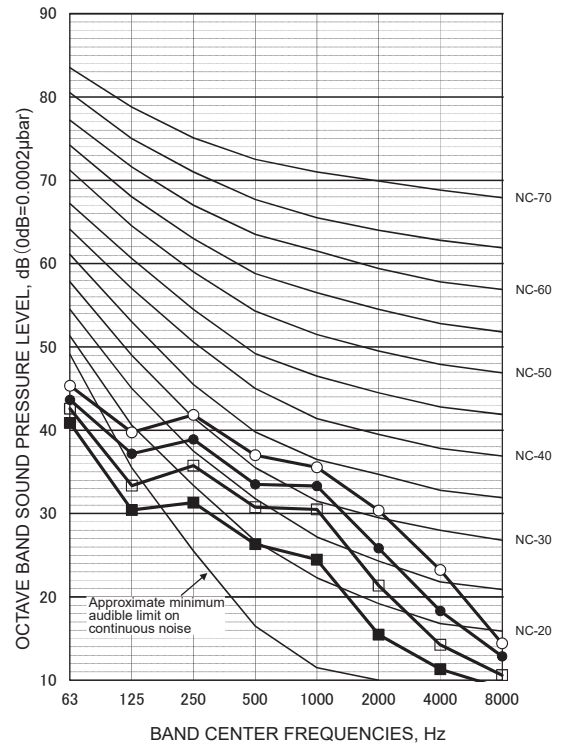

**PKFY-P50VLM-(E/ET)**

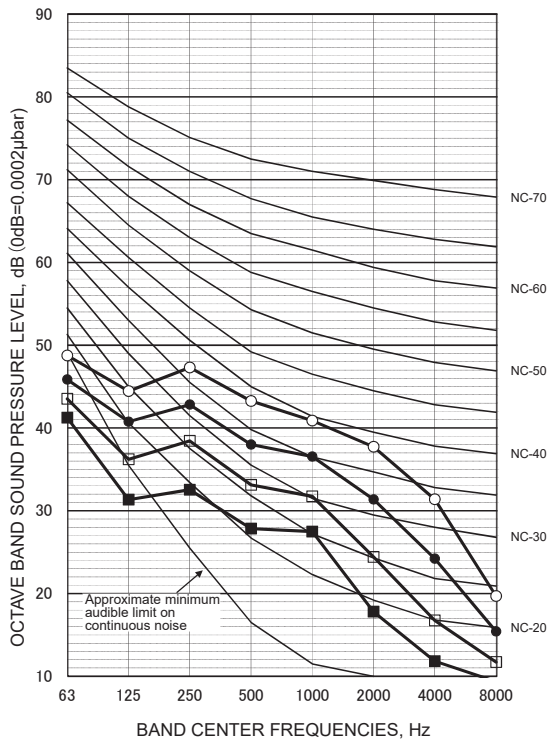

PKFY-P10VLM-(ER1/ETR1).TH  
 PKFY-P20VLM-(ER1/ETR1).TH  
 PKFY-P32VLM-(ER1/ETR1).TH

PKFY-P15VLM-(ER1/ETR1).TH  
 PKFY-P25VLM-(ER1/ETR1).TH

Unit: mm

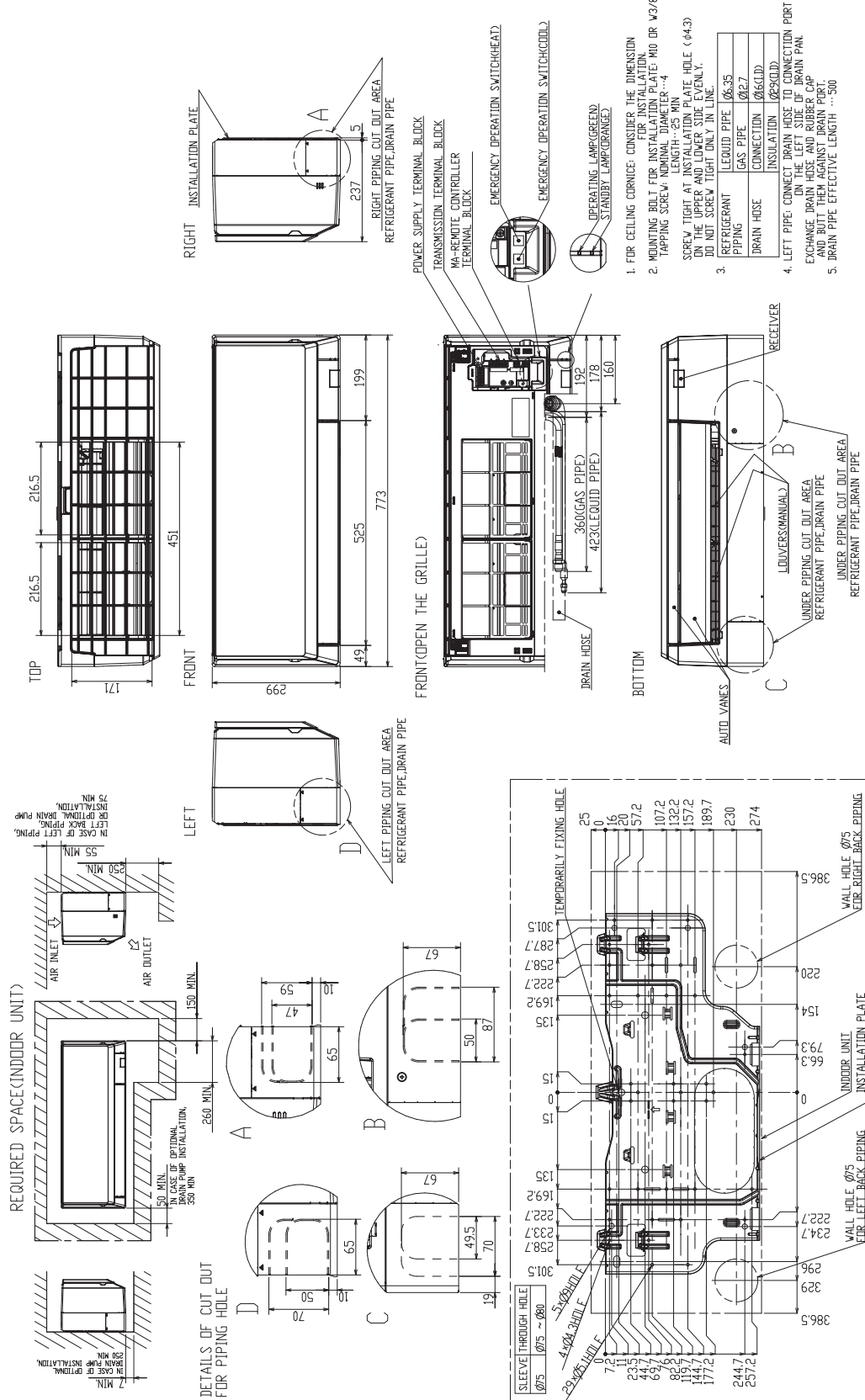



PKFY-P10VLM-(ER1/ETR1).TH  
 PKFY-P20VLM-(ER1/ETR1).TH  
 PKFY-P32VLM-(ER1/ETR1).TH  
 PKFY-P50VLM-(ER1/ETR1).TH

PKFY-P15VLM-(ER1/ETR1).TH  
 PKFY-P25VLM-(ER1/ETR1).TH  
 PKFY-P40VLM-(ER1/ETR1).TH

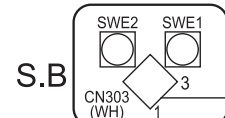
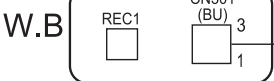
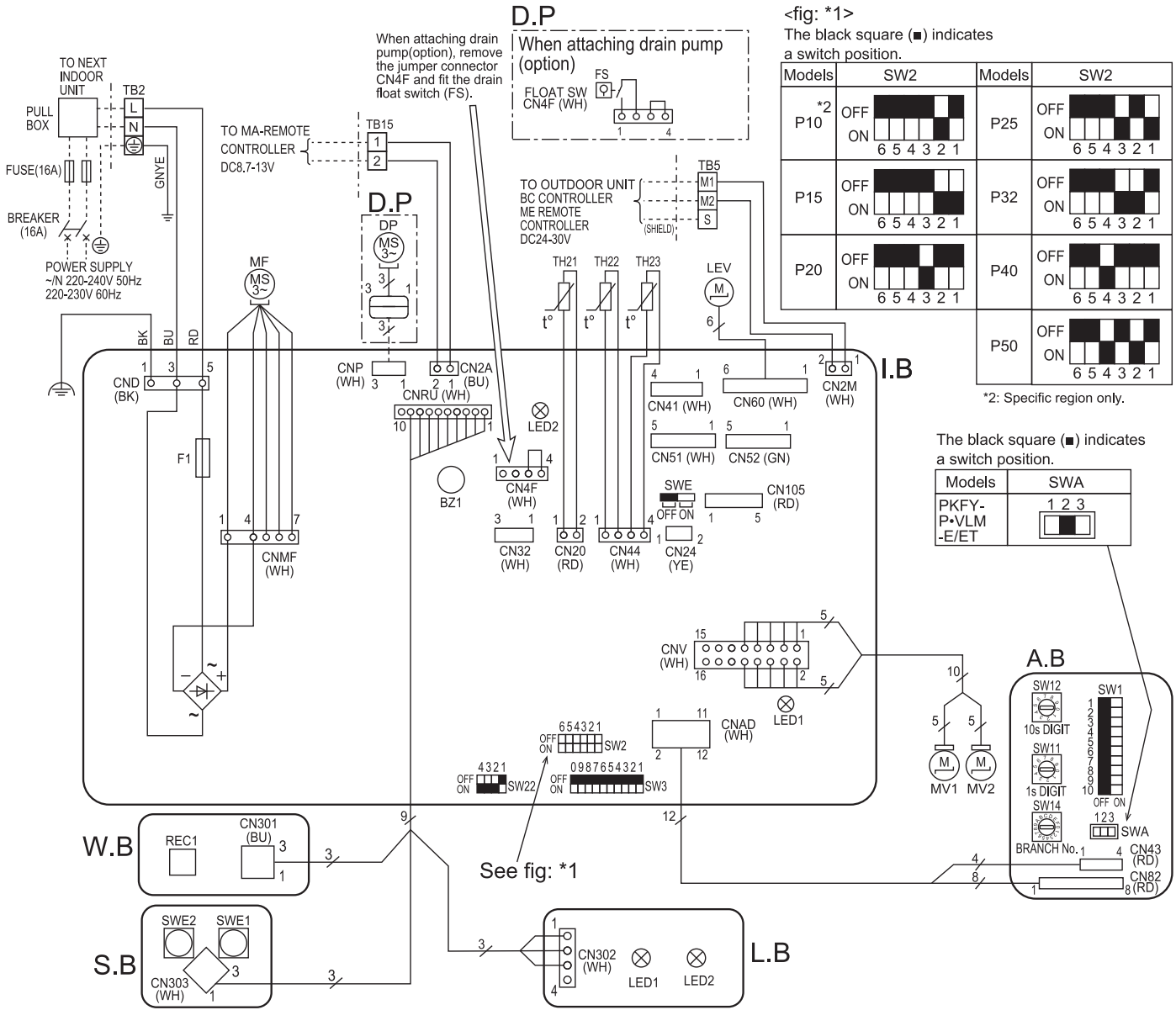

See fig: \*1

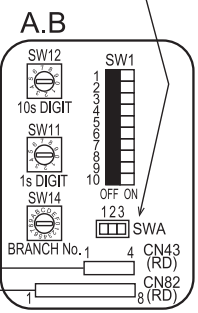
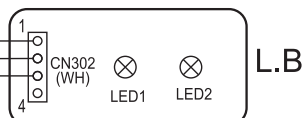

SYMBOL	NAME	SYMBOL	NAME
I.B	INDOOR CONTROLLER BOARD	TH21	THERMISTOR ROOM TEMP. DETECTION (0°C/15kΩ, 25°C/5.4kΩ)
CN32	CONNECTOR REMOTE SWITCH	TH22	PIPE TEMP. DETECTION / LIQUID (0°C/15kΩ, 25°C/5.4kΩ)
CN51	CENTRALLY CONTROL	TH23	PIPE TEMP. DETECTION / GAS (0°C/15kΩ, 25°C/5.4kΩ)
CN52	REMOTE INDICATION	A.B	ADDRESS BOARD
CN105	IT TERMINAL	SWA	SWITCH REGION SELECTION
BZ1	BUZZER	SW1	MODE SELECTION
F1	FUSE (T3.15A/250V)	SW11	ADDRESS SETTING 1s DIGIT
LED1	POWER SUPPLY (I.B)	SW12	ADDRESS SETTING 10s DIGIT
LED2	POWER SUPPLY (MA-REMOTE CONTROLLER)	SW14	BRANCH No.
SW2	SWITCH CAPACITY CODE	S.B	SWITCH BOARD
SW3	MODE SELECTION	SWE1	EMERGENCY OPERATION(HEAT)
SW22	PAIR NO. SETTING	SWE2	EMERGENCY OPERATION(COOL)
SWE	FAN-DRAIN PUMP (TEST MODE)	W.B	PCB FOR WIRELESS REMOTE CONTROLLER
LEV	LINEAR EXPANSION VALVE	REC1	RECEIVING UNIT
MF	FAN MOTOR	L.B	LED BOARD
MV1	VANE MOTOR (UPPER)	LED1	LED(OPERATING INDICATOR:GREEN)
MV2	VANE MOTOR (LOWER)	LED2	LED(STANDBY FOR HEATING : ORANGE)
TB2	TERMINAL POWER SUPPLY	D.P	DRAIN PUMP KIT (OPTION)
TB5	BLOCK TRANSMISSION	FS	DRAIN FLOAT SWITCH
TB15	BLOCK MA-REMOTE CONTROLLER	DP	DRAIN PUMP

- NOTES:**
- At servicing for outdoor unit, always follow the wiring diagram of outdoor unit.
  - In case of using MA-Remote controller, please connect to TB15. (Remote controller wire is non-polar.)
  - In case of using M-NET, please connect to TB5. (Transmission line is non-polar.)
  - Symbol [S] of TB5 is the shield wire connection.
  - Symbols used in wiring diagram above are, [ ] : terminal block, [ ] : connector.
  - The setting of the SW2 dip switches differs in the capacity. For the detail, refer to the fig: \*1.

**LED on indoor controller board for service**

Symbol	Meaning	Function
LED1	Main power supply	Main power supply (Indoor unit:220-240V) Power on → Lamp is lit
LED2	Power supply for MA-Remote controller	Power supply for MA-Remote controller on → Lamp is lit

# 7

# REFRIGERANT SYSTEM DIAGRAM

PKFY-P10VLM-(ER1/ETR1).TH  
 PKFY-P20VLM-(ER1/ETR1).TH  
 PKFY-P32VLM-(ER1/ETR1).TH  
 PKFY-P50VLM-(ER1/ETR1).TH

PKFY-P15VLM-(ER1/ETR1).TH  
 PKFY-P25VLM-(ER1/ETR1).TH  
 PKFY-P40VLM-(ER1/ETR1).TH

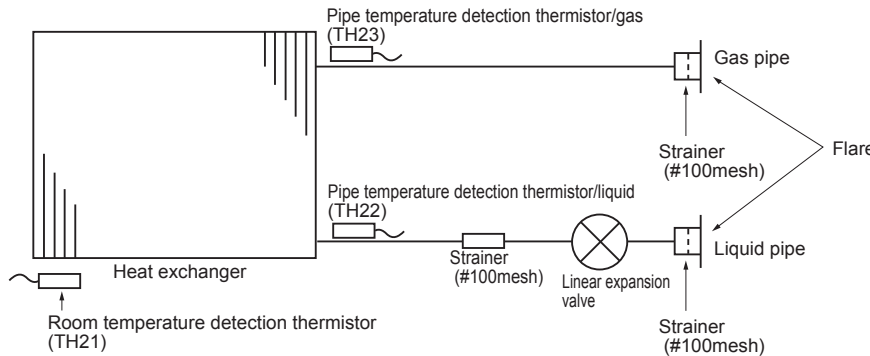

Unit: mm (inch)	
Gas pipe	φ12.7 (1/2")
Liquid pipe	φ6.35 (1/4")

# 8

# TROUBLESHOOTING

## 8-1. HOW TO CHECK THE PARTS

PKFY-P10VLM-(ER1/ETR1).TH  
 PKFY-P20VLM-(ER1/ETR1).TH  
 PKFY-P32VLM-(ER1/ETR1).TH  
 PKFY-P50VLM-(ER1/ETR1).TH

PKFY-P15VLM-(ER1/ETR1).TH  
 PKFY-P25VLM-(ER1/ETR1).TH  
 PKFY-P40VLM-(ER1/ETR1).TH

Parts name	Check points																
Room temperature detection thermistor (TH21) Pipe temperature detection thermistor/liquid (TH22) Pipe temperature detection thermistor/gas (TH23)	Disconnect the connector then measure the resistance with a tester. (At the ambient temperature 10 to 30°C) <table border="1"> <tr> <td>Normal</td> <td rowspan="2">Refer to "8-1-1. Thermistor".</td> </tr> <tr> <td>4.3 to 9.6kΩ</td> </tr> </table>	Normal	Refer to "8-1-1. Thermistor".	4.3 to 9.6kΩ													
Normal	Refer to "8-1-1. Thermistor".																
4.3 to 9.6kΩ																	
Vane motor (MV1) 	Measure the resistance between the terminals with a tester. (At the ambient temperature 25°C) <table border="1"> <tr> <td colspan="4">Normal</td> </tr> <tr> <td>⑩-⑨</td> <td>⑩-⑧</td> <td>⑩-⑦</td> <td>⑩-⑥</td> </tr> <tr> <td>Red-Sky Blue</td> <td>Red-Sky Blue</td> <td>Red-Sky Blue</td> <td>Red-Sky Blue</td> </tr> <tr> <td colspan="4">300 Ω±7%</td> </tr> </table>	Normal				⑩-⑨	⑩-⑧	⑩-⑦	⑩-⑥	Red-Sky Blue	Red-Sky Blue	Red-Sky Blue	Red-Sky Blue	300 Ω±7%			
Normal																	
⑩-⑨	⑩-⑧	⑩-⑦	⑩-⑥														
Red-Sky Blue	Red-Sky Blue	Red-Sky Blue	Red-Sky Blue														
300 Ω±7%																	
Vane motor (Lower (MV2)) 	Measure the resistance between the terminals with a tester. (At the ambient temperature 25°C) <table border="1"> <tr> <td colspan="4">Normal</td> </tr> <tr> <td>⑤-④</td> <td>⑤-③</td> <td>⑤-②</td> <td>⑤-①</td> </tr> <tr> <td>Red-Sky Blue</td> <td>Red-Sky Blue</td> <td>Red-Sky Blue</td> <td>Red-Sky Blue</td> </tr> <tr> <td colspan="4">300±26.3 Ω</td> </tr> </table>	Normal				⑤-④	⑤-③	⑤-②	⑤-①	Red-Sky Blue	Red-Sky Blue	Red-Sky Blue	Red-Sky Blue	300±26.3 Ω			
Normal																	
⑤-④	⑤-③	⑤-②	⑤-①														
Red-Sky Blue	Red-Sky Blue	Red-Sky Blue	Red-Sky Blue														
300±26.3 Ω																	
Fan motor (MF)	Refer to "8-1-3. DC Fan motor (fan motor/indoor controller board)																
Linear expansion valve (LEV) 	Disconnect the connector then measure the resistance valve with a tester. (Coil temperature 20°C) <table border="1"> <tr> <td colspan="4">Normal</td> </tr> <tr> <td>(1)-(5)</td> <td>(2)-(6)</td> <td>(3)-(5)</td> <td>(4)-(6)</td> </tr> <tr> <td>White-Red</td> <td>Yellow-Brown</td> <td>Orange-Red</td> <td>Blue-Brown</td> </tr> <tr> <td colspan="4">200 Ω±10%</td> </tr> </table>	Normal				(1)-(5)	(2)-(6)	(3)-(5)	(4)-(6)	White-Red	Yellow-Brown	Orange-Red	Blue-Brown	200 Ω±10%			
Normal																	
(1)-(5)	(2)-(6)	(3)-(5)	(4)-(6)														
White-Red	Yellow-Brown	Orange-Red	Blue-Brown														
200 Ω±10%																	
Drain pump (DP) 	① Check if the drain float switch works properly. ② Check if the drain pump works and drains water properly in cooling operation. ③ If no water drains, confirm that the check code 2502 will not be displayed 10 minutes after the operation starts. Note: The drain pump for this model is driven by the internal DC motor, so it is not possible to measure the resistance between the terminals. Normal Red-Black: Input 13 V DC → The pump motor starts to rotate.																
Drain float switch (FS) 	Measure the resistance between the terminals with a tester. <table border="1"> <thead> <tr> <th>State of moving part</th> <th>Normal</th> <th>Abnormal</th> <th>Drain float switch connector terminal</th> </tr> </thead> <tbody> <tr> <td>UP</td> <td>Short</td> <td>Other than short</td> <td>①(+)-②(-)</td> </tr> <tr> <td>DOWN</td> <td>Open</td> <td>Other than open</td> <td>①(+)-②(-)</td> </tr> <tr> <td>-</td> <td>Short</td> <td>Other than short</td> <td>③(+)-④(-)</td> </tr> </tbody> </table>	State of moving part	Normal	Abnormal	Drain float switch connector terminal	UP	Short	Other than short	①(+)-②(-)	DOWN	Open	Other than open	①(+)-②(-)	-	Short	Other than short	③(+)-④(-)
State of moving part	Normal	Abnormal	Drain float switch connector terminal														
UP	Short	Other than short	①(+)-②(-)														
DOWN	Open	Other than open	①(+)-②(-)														
-	Short	Other than short	③(+)-④(-)														

## 8-1-1. Thermistor

<Thermistor characteristic graph>

Thermistor for lower temperature

Room temperature detection thermistor (TH21)  
 Pipe temperature detection thermistor/liquid (TH22)  
 Pipe temperature detection thermistor/gas (TH23)

Thermistor  $R_0=15 \text{ k}\Omega \pm 3\%$

Fixed number of  $B=3480 \pm 2\%$

$$R_t = 15 \exp \left\{ 3480 \left( \frac{1}{273+t} - \frac{1}{273} \right) \right\}$$

0°C	15 kΩ
10°C	9.6 kΩ
20°C	6.3 kΩ
25°C	5.4 kΩ
30°C	4.3 kΩ
40°C	3.0 kΩ

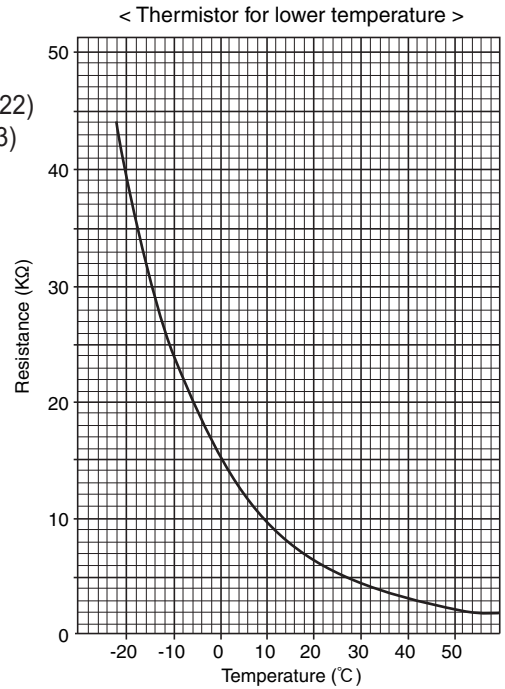

## 8-1-2. Linear expansion valve

### ① Operation summary of the linear expansion valve

- Linear expansion valve opens/closes through stepping motor after receiving the pulse signal from the indoor controller board.
- Valve position can be changed in proportion to the number of pulse signal.

<Connection between the indoor controller board and the linear expansion valve>

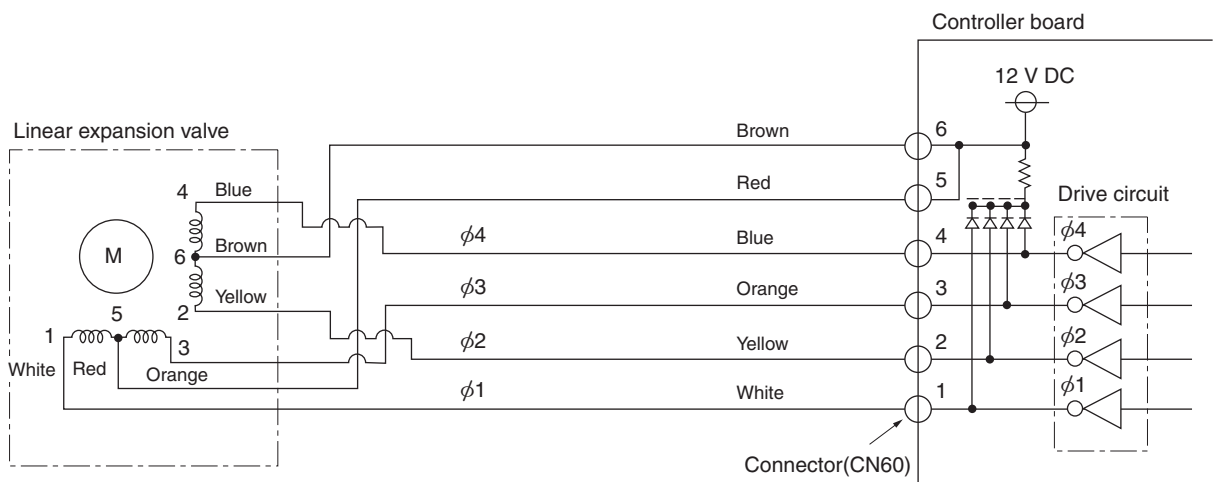

Note : Since the number of the connector at the controller board side and the relay connector are different, follow the color of the lead wire.

### 8-1-3. DC Fan motor (fan motor/indoor controller board)

Check method of indoor fan motor (fan motor/indoor controller board)

① Notes

- High voltage is applied to the connector (CNMF) for the fan motor. Pay attention to the service.
- Do not pull out the connector (CNMF) for the motor with the power supply on.  
(It causes trouble of the indoor controller board and fan motor.)

② Self check

Conditions : The indoor fan cannot rotate.

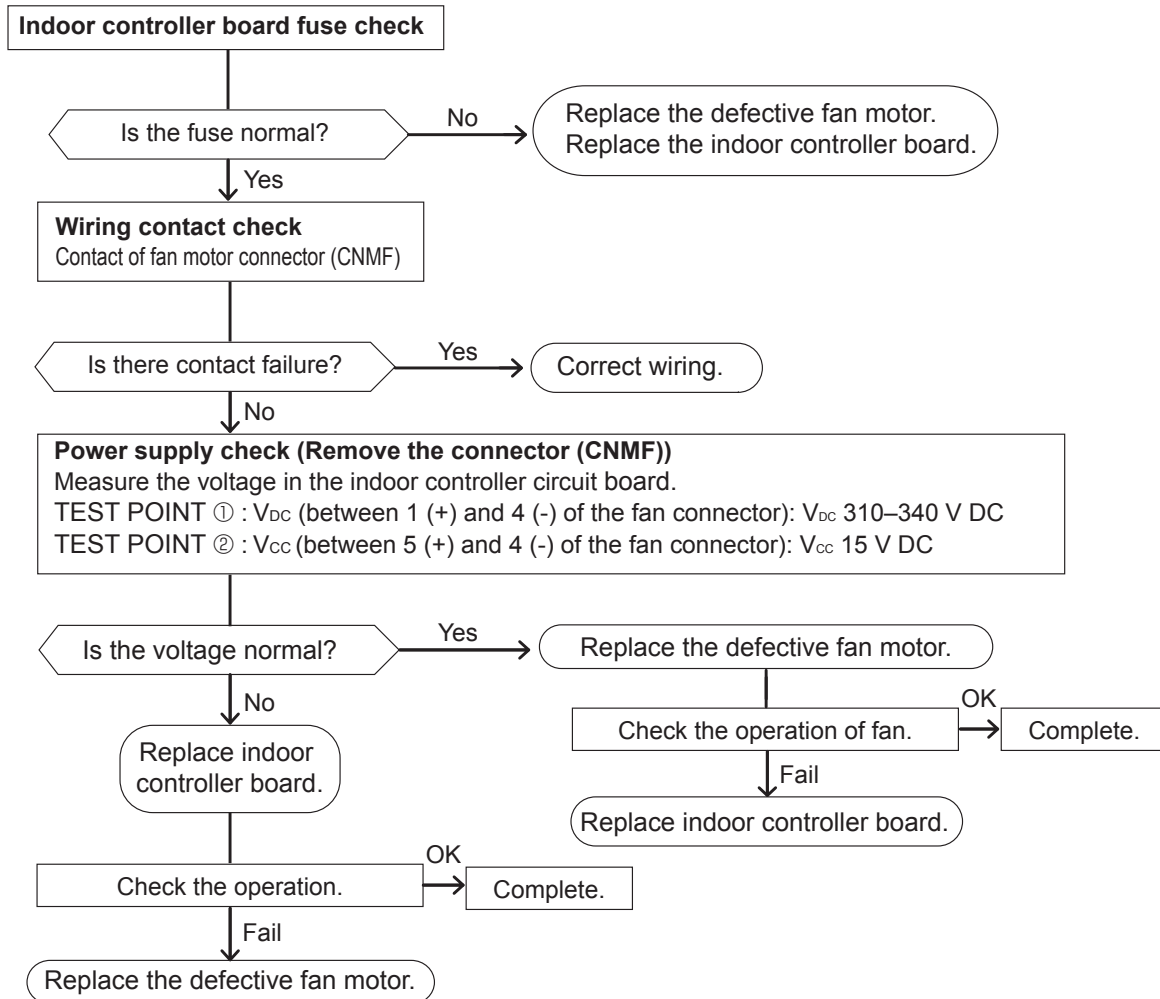

### <Output pulse signal and the valve operation>

Output (Phase)	Output			
	1	2	3	4
φ1	ON	OFF	OFF	ON
φ2	ON	ON	OFF	OFF
φ3	OFF	ON	ON	OFF
φ4	OFF	OFF	ON	ON

The output pulse shifts in below order.  
 Closing a valve : 1 → 2 → 3 → 4 → 1  
 Opening a valve : 4 → 3 → 2 → 1 → 4

- When linear expansion valve operation stops, all output phase become OFF.
- At phase interruption or when phase does not shift in order, motor does not rotate smoothly and motor will lock and vibrate.

### ② Linear expansion valve operation

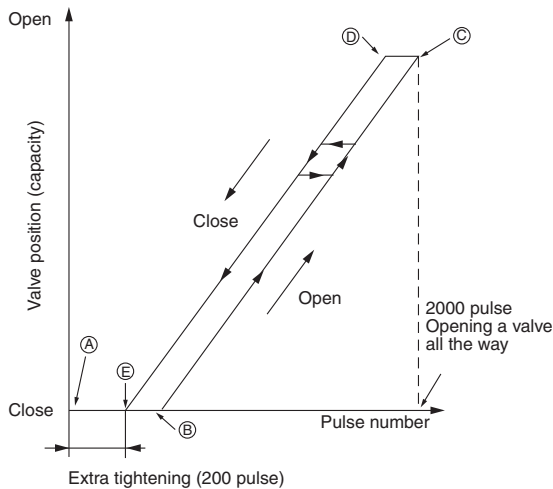

- When the power is turned on, 2200 pulse closing valve signal will be sent till it goes to point A in order to define the valve position.
- When the valve moves smoothly, there is no noise or vibration occurring from the linear expansion valves : however, when the pulse number moves from E to A or when the valve is locked, more noise can be heard than in a normal situation.
- Noise can be detected by placing the ear against the screw driver handle while putting the screw driver tip to the linear expansion valve.

### ③ Troubleshooting

Symptom	Check points	Countermeasures
Operation circuit failure of the micro-processor	Disconnect the connector on the controller board, then connect LED for checking.  1kΩ LED	Exchange the indoor controller board at drive circuit failure.
Linear expansion valve mechanism is locked.	Motor will idle and make a ticking noise when the motor is operated while the linear expansion valve is locked. This ticking sound is the sign of the abnormality.	Exchange the linear expansion valve.
Short or breakage of the motor coil of the linear expansion valve	Measure the resistance between each coil (white-red, yellow-brown, orange-red, blue-brown) using a tester. It is normal if the resistance is in the range of 200 Ω ±10%.	Exchange the linear expansion valve.
Valve does not close completely.	To check the linear expansion valve, operate the indoor unit in fan mode and at the same time operate other indoor units in cooling mode, then check the pipe temperature <liquid pipe temperature> of the indoor unit by the outdoor multi controller board operation monitor. During fan operation, linear expansion valve is closed completely and if there is any leaking, detecting temperature of the thermistor will go lower. If the detected temperature is much lower than the temperature indicated in the remote controller, it means the valve is not closed all the way.  Thermistor (Liquid pipe) Linear expansion valve	If large amount of refrigerant is leaked, exchange the linear expansion valve.
Wrong connection of the connector or contact failure	Check the color of lead wire and missing terminal of the connector.	Disconnect the connector at the controller board, then check the continuity.



## 8-2. FUNCTION OF DIP SWITCH

PKFY-P10VLM-(ER1/ETR1).TH  
 PKFY-P20VLM-(ER1/ETR1).TH  
 PKFY-P32VLM-(ER1/ETR1).TH  
 PKFY-P50VLM-(ER1/ETR1).TH

PKFY-P15VLM-(ER1/ETR1).TH  
 PKFY-P25VLM-(ER1/ETR1).TH  
 PKFY-P40VLM-(ER1/ETR1).TH

The black square (■) indicates a switch position.









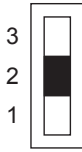
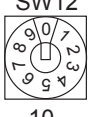
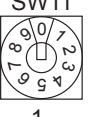
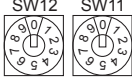
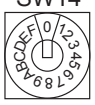

Switch	Pole	Function	Operation by switch		Effective timing	Remarks																																																																																																																																																														
			ON	OFF																																																																																																																																																																
SW1 Mode Selection	1	Thermistor <Intake temperature detection> position	Built-in remote controller	Indoor unit	Under suspension	<div style="border: 1px solid black; padding: 2px; width: fit-content; margin-bottom: 5px;">Address board</div> <Initial setting> ON <table style="display: inline-table; border-collapse: collapse;"><tr><td style="width: 10px; height: 10px; background-color: white;"></td><td style="width: 10px; height: 10px; background-color: white;"></td><td style="width: 10px; height: 10px; background-color: white;"></td><td style="width: 10px; height: 10px; background-color: white;"></td><td style="width: 10px; height: 10px; background-color: white;"></td><td style="width: 10px; height: 10px; background-color: white;"></td><td style="width: 10px; height: 10px; background-color: white;"></td><td style="width: 10px; height: 10px; background-color: white;"></td><td style="width: 10px; height: 10px; background-color: white;"></td><td style="width: 10px; height: 10px; background-color: white;"></td></tr></table> OFF <table style="display: inline-table; border-collapse: collapse;"><tr><td style="width: 10px; height: 10px; background-color: black;"></td><td style="width: 10px; height: 10px; background-color: black;"></td><td style="width: 10px; height: 10px; background-color: black;"></td><td style="width: 10px; height: 10px; background-color: black;"></td><td style="width: 10px; height: 10px; background-color: black;"></td><td style="width: 10px; height: 10px; background-color: black;"></td><td style="width: 10px; height: 10px; background-color: black;"></td><td style="width: 10px; height: 10px; background-color: black;"></td><td style="width: 10px; height: 10px; background-color: black;"></td><td style="width: 10px; height: 10px; background-color: black;"></td></tr></table> 1 2 3 4 5 6 7 8 9 10																																																																																																																																																														
	2	Filter clogging	Provided	Not provided																																																																																																																																																																
	3	Filter sign indication	2,500 hr	100 hr																																																																																																																																																																
	4	Air intake*1	Not effective	Not effective																																																																																																																																																																
	5	Remote indication switching	Thermo-ON signal indication	Fan output indication																																																																																																																																																																
	6	Humidifier control	Fan operation at Heating mode	Thermo-ON operation at heating mode																																																																																																																																																																
	7	Air flow set in case of heat thermo-OFF	Low*2	Extra low*2																																																																																																																																																																
	8		Setting air flow*1	Depends on SW1-7																																																																																																																																																																
9	Auto restart function	Effective	Not effective																																																																																																																																																																	
10	Power ON/OFF	Effective	Not effective																																																																																																																																																																	
SW2 Capacity code setting	1-4	<table border="1" style="width: 100%; border-collapse: collapse;"> <thead> <tr> <th>Models</th> <th>SW2</th> <th>Models</th> <th>SW2</th> </tr> </thead> <tbody> <tr> <td>P10</td> <td>                     OFF <table style="display: inline-table; border-collapse: collapse;"><tr><td style="width: 10px; height: 10px; background-color: white;"></td><td style="width: 10px; height: 10px; background-color: black;"></td><td style="width: 10px; height: 10px; background-color: white;"></td><td style="width: 10px; height: 10px; background-color: white;"></td><td style="width: 10px; height: 10px; background-color: white;"></td><td style="width: 10px; height: 10px; background-color: white;"></td><td style="width: 10px; height: 10px; background-color: white;"></td><td style="width: 10px; height: 10px; background-color: white;"></td><td style="width: 10px; height: 10px; background-color: white;"></td><td style="width: 10px; height: 10px; background-color: white;"></td></tr></table>                      ON <table style="display: inline-table; border-collapse: collapse;"><tr><td style="width: 10px; height: 10px; background-color: white;"></td><td style="width: 10px; height: 10px; background-color: white;"></td><td style="width: 10px; height: 10px; background-color: white;"></td><td style="width: 10px; height: 10px; background-color: white;"></td><td style="width: 10px; height: 10px; background-color: white;"></td><td style="width: 10px; height: 10px; background-color: white;"></td><td style="width: 10px; height: 10px; background-color: white;"></td><td style="width: 10px; height: 10px; background-color: white;"></td><td style="width: 10px; height: 10px; background-color: white;"></td><td style="width: 10px; height: 10px; background-color: white;"></td></tr></table>                      6 5 4 3 2 1                 </td> <td>P25</td> <td>                     OFF <table style="display: inline-table; border-collapse: collapse;"><tr><td style="width: 10px; height: 10px; background-color: white;"></td><td style="width: 10px; height: 10px; background-color: black;"></td><td style="width: 10px; height: 10px; background-color: white;"></td><td style="width: 10px; height: 10px; background-color: white;"></td><td style="width: 10px; height: 10px; background-color: white;"></td><td style="width: 10px; height: 10px; background-color: white;"></td><td style="width: 10px; height: 10px; background-color: white;"></td><td style="width: 10px; height: 10px; background-color: white;"></td><td style="width: 10px; height: 10px; background-color: white;"></td><td style="width: 10px; height: 10px; background-color: white;"></td></tr></table>                      ON <table style="display: inline-table; border-collapse: collapse;"><tr><td style="width: 10px; height: 10px; background-color: white;"></td><td style="width: 10px; height: 10px; background-color: white;"></td><td style="width: 10px; height: 10px; background-color: white;"></td><td style="width: 10px; height: 10px; background-color: white;"></td><td style="width: 10px; height: 10px; background-color: white;"></td><td style="width: 10px; height: 10px; background-color: white;"></td><td style="width: 10px; height: 10px; background-color: white;"></td><td style="width: 10px; height: 10px; background-color: white;"></td><td style="width: 10px; height: 10px; background-color: white;"></td><td style="width: 10px; height: 10px; background-color: white;"></td></tr></table>                      6 5 4 3 2 1                 </td> </tr> <tr> <td>P15</td> <td>                     OFF <table style="display: inline-table; border-collapse: collapse;"><tr><td style="width: 10px; height: 10px; background-color: white;"></td><td style="width: 10px; height: 10px; background-color: white;"></td><td style="width: 10px; height: 10px; background-color: white;"></td><td style="width: 10px; height: 10px; background-color: white;"></td><td style="width: 10px; height: 10px; background-color: white;"></td><td style="width: 10px; height: 10px; background-color: white;"></td><td style="width: 10px; height: 10px; background-color: white;"></td><td style="width: 10px; height: 10px; background-color: white;"></td><td style="width: 10px; height: 10px; background-color: white;"></td><td style="width: 10px; height: 10px; background-color: white;"></td></tr></table>                      ON <table style="display: inline-table; border-collapse: collapse;"><tr><td style="width: 10px; height: 10px; background-color: white;"></td><td style="width: 10px; height: 10px; background-color: white;"></td><td style="width: 10px; height: 10px; background-color: white;"></td><td style="width: 10px; height: 10px; background-color: white;"></td><td style="width: 10px; height: 10px; background-color: white;"></td><td style="width: 10px; height: 10px; background-color: white;"></td><td style="width: 10px; height: 10px; background-color: white;"></td><td style="width: 10px; height: 10px; background-color: white;"></td><td style="width: 10px; height: 10px; background-color: white;"></td><td style="width: 10px; height: 10px; background-color: white;"></td></tr></table>                      6 5 4 3 2 1                 </td> <td>P32</td> <td>                     OFF <table style="display: inline-table; border-collapse: collapse;"><tr><td style="width: 10px; height: 10px; background-color: white;"></td><td style="width: 10px; height: 10px; background-color: white;"></td><td style="width: 10px; height: 10px; background-color: white;"></td><td style="width: 10px; height: 10px; background-color: white;"></td><td style="width: 10px; height: 10px; background-color: white;"></td><td style="width: 10px; height: 10px; background-color: white;"></td><td style="width: 10px; height: 10px; background-color: white;"></td><td style="width: 10px; height: 10px; background-color: white;"></td><td style="width: 10px; height: 10px; background-color: white;"></td><td style="width: 10px; height: 10px; background-color: white;"></td></tr></table>                      ON <table style="display: inline-table; border-collapse: collapse;"><tr><td style="width: 10px; height: 10px; background-color: white;"></td><td style="width: 10px; height: 10px; background-color: white;"></td><td style="width: 10px; height: 10px; background-color: white;"></td><td style="width: 10px; height: 10px; background-color: white;"></td><td style="width: 10px; height: 10px; background-color: white;"></td><td style="width: 10px; height: 10px; background-color: white;"></td><td style="width: 10px; height: 10px; background-color: white;"></td><td style="width: 10px; height: 10px; background-color: white;"></td><td style="width: 10px; height: 10px; background-color: white;"></td><td style="width: 10px; height: 10px; background-color: white;"></td></tr></table>                      6 5 4 3 2 1                 </td> </tr> <tr> <td>P20</td> <td>                     OFF <table style="display: inline-table; border-collapse: collapse;"><tr><td style="width: 10px; height: 10px; background-color: white;"></td><td style="width: 10px; height: 10px; background-color: white;"></td><td style="width: 10px; height: 10px; background-color: white;"></td><td style="width: 10px; height: 10px; background-color: white;"></td><td style="width: 10px; height: 10px; background-color: white;"></td><td style="width: 10px; height: 10px; background-color: white;"></td><td style="width: 10px; height: 10px; background-color: white;"></td><td style="width: 10px; height: 10px; background-color: white;"></td><td style="width: 10px; height: 10px; background-color: white;"></td><td style="width: 10px; height: 10px; background-color: white;"></td></tr></table>                      ON <table style="display: inline-table; border-collapse: collapse;"><tr><td style="width: 10px; height: 10px; background-color: white;"></td><td style="width: 10px; height: 10px; background-color: white;"></td><td style="width: 10px; height: 10px; background-color: white;"></td><td style="width: 10px; height: 10px; background-color: white;"></td><td style="width: 10px; height: 10px; background-color: white;"></td><td style="width: 10px; height: 10px; background-color: white;"></td><td style="width: 10px; height: 10px; background-color: white;"></td><td style="width: 10px; height: 10px; background-color: white;"></td><td style="width: 10px; height: 10px; background-color: white;"></td><td style="width: 10px; height: 10px; background-color: white;"></td></tr></table>                      6 5 4 3 2 1                 </td> <td>P40</td> <td>                     OFF <table style="display: inline-table; border-collapse: collapse;"><tr><td style="width: 10px; height: 10px; background-color: white;"></td><td style="width: 10px; height: 10px; background-color: white;"></td><td style="width: 10px; height: 10px; background-color: white;"></td><td style="width: 10px; height: 10px; background-color: white;"></td><td style="width: 10px; height: 10px; background-color: white;"></td><td style="width: 10px; height: 10px; background-color: white;"></td><td style="width: 10px; height: 10px; background-color: white;"></td><td style="width: 10px; height: 10px; background-color: white;"></td><td style="width: 10px; height: 10px; background-color: white;"></td><td style="width: 10px; height: 10px; background-color: white;"></td></tr></table>                      ON <table style="display: inline-table; border-collapse: collapse;"><tr><td style="width: 10px; height: 10px; background-color: white;"></td><td style="width: 10px; height: 10px; background-color: white;"></td><td style="width: 10px; height: 10px; background-color: white;"></td><td style="width: 10px; height: 10px; background-color: white;"></td><td style="width: 10px; height: 10px; background-color: white;"></td><td style="width: 10px; height: 10px; background-color: white;"></td><td style="width: 10px; height: 10px; background-color: white;"></td><td style="width: 10px; height: 10px; background-color: white;"></td><td style="width: 10px; height: 10px; background-color: white;"></td><td style="width: 10px; height: 10px; background-color: white;"></td></tr></table>                      6 5 4 3 2 1                 </td> </tr> <tr> <td></td> <td></td> <td>P50</td> <td>                     OFF <table style="display: inline-table; border-collapse: collapse;"><tr><td style="width: 10px; height: 10px; background-color: white;"></td><td style="width: 10px; height: 10px; background-color: white;"></td><td style="width: 10px; height: 10px; background-color: white;"></td><td style="width: 10px; height: 10px; background-color: white;"></td><td style="width: 10px; height: 10px; background-color: white;"></td><td style="width: 10px; height: 10px; background-color: white;"></td><td style="width: 10px; height: 10px; background-color: white;"></td><td style="width: 10px; height: 10px; background-color: white;"></td><td style="width: 10px; height: 10px; background-color: white;"></td><td style="width: 10px; height: 10px; background-color: white;"></td></tr></table>                      ON <table style="display: inline-table; border-collapse: collapse;"><tr><td style="width: 10px; height: 10px; background-color: white;"></td><td style="width: 10px; height: 10px; background-color: white;"></td><td style="width: 10px; height: 10px; background-color: white;"></td><td style="width: 10px; height: 10px; background-color: white;"></td><td style="width: 10px; height: 10px; background-color: white;"></td><td style="width: 10px; height: 10px; background-color: white;"></td><td style="width: 10px; height: 10px; background-color: white;"></td><td style="width: 10px; height: 10px; background-color: white;"></td><td style="width: 10px; height: 10px; background-color: white;"></td><td style="width: 10px; height: 10px; background-color: white;"></td></tr></table>                      6 5 4 3 2 1                 </td> </tr> </tbody> </table>	Models	SW2	Models	SW2	P10	OFF <table style="display: inline-table; border-collapse: collapse;"><tr><td style="width: 10px; height: 10px; background-color: white;"></td><td style="width: 10px; height: 10px; background-color: black;"></td><td style="width: 10px; height: 10px; background-color: white;"></td><td style="width: 10px; height: 10px; background-color: white;"></td><td style="width: 10px; height: 10px; background-color: white;"></td><td style="width: 10px; height: 10px; background-color: white;"></td><td style="width: 10px; height: 10px; background-color: white;"></td><td style="width: 10px; height: 10px; background-color: white;"></td><td style="width: 10px; height: 10px; background-color: white;"></td><td style="width: 10px; height: 10px; background-color: white;"></td></tr></table> ON <table style="display: inline-table; border-collapse: collapse;"><tr><td style="width: 10px; height: 10px; background-color: white;"></td><td style="width: 10px; height: 10px; background-color: white;"></td><td style="width: 10px; height: 10px; background-color: white;"></td><td style="width: 10px; height: 10px; background-color: white;"></td><td style="width: 10px; height: 10px; background-color: white;"></td><td style="width: 10px; height: 10px; background-color: white;"></td><td style="width: 10px; height: 10px; background-color: white;"></td><td style="width: 10px; height: 10px; background-color: white;"></td><td style="width: 10px; height: 10px; background-color: white;"></td><td style="width: 10px; height: 10px; background-color: white;"></td></tr></table> 6 5 4 3 2 1																					P25	OFF <table style="display: inline-table; border-collapse: collapse;"><tr><td style="width: 10px; height: 10px; background-color: white;"></td><td style="width: 10px; height: 10px; background-color: black;"></td><td style="width: 10px; height: 10px; background-color: white;"></td><td style="width: 10px; height: 10px; background-color: white;"></td><td style="width: 10px; height: 10px; background-color: white;"></td><td style="width: 10px; height: 10px; background-color: white;"></td><td style="width: 10px; height: 10px; background-color: white;"></td><td style="width: 10px; height: 10px; background-color: white;"></td><td style="width: 10px; height: 10px; background-color: white;"></td><td style="width: 10px; height: 10px; background-color: white;"></td></tr></table> ON <table style="display: inline-table; border-collapse: collapse;"><tr><td style="width: 10px; height: 10px; background-color: white;"></td><td style="width: 10px; height: 10px; background-color: white;"></td><td style="width: 10px; height: 10px; background-color: white;"></td><td style="width: 10px; height: 10px; background-color: white;"></td><td style="width: 10px; height: 10px; background-color: white;"></td><td style="width: 10px; height: 10px; background-color: white;"></td><td style="width: 10px; height: 10px; background-color: white;"></td><td style="width: 10px; height: 10px; background-color: white;"></td><td style="width: 10px; height: 10px; background-color: white;"></td><td style="width: 10px; height: 10px; background-color: white;"></td></tr></table> 6 5 4 3 2 1																					P15	OFF <table style="display: inline-table; border-collapse: collapse;"><tr><td style="width: 10px; height: 10px; background-color: white;"></td><td style="width: 10px; height: 10px; background-color: white;"></td><td style="width: 10px; height: 10px; background-color: white;"></td><td style="width: 10px; height: 10px; background-color: white;"></td><td style="width: 10px; height: 10px; background-color: white;"></td><td style="width: 10px; height: 10px; background-color: white;"></td><td style="width: 10px; height: 10px; background-color: white;"></td><td style="width: 10px; height: 10px; background-color: white;"></td><td style="width: 10px; height: 10px; background-color: white;"></td><td style="width: 10px; height: 10px; background-color: white;"></td></tr></table> ON <table style="display: inline-table; border-collapse: collapse;"><tr><td style="width: 10px; height: 10px; background-color: white;"></td><td style="width: 10px; height: 10px; background-color: white;"></td><td style="width: 10px; height: 10px; background-color: white;"></td><td style="width: 10px; height: 10px; background-color: white;"></td><td style="width: 10px; height: 10px; background-color: white;"></td><td style="width: 10px; height: 10px; background-color: white;"></td><td style="width: 10px; height: 10px; background-color: white;"></td><td style="width: 10px; height: 10px; background-color: white;"></td><td style="width: 10px; height: 10px; background-color: white;"></td><td style="width: 10px; height: 10px; background-color: white;"></td></tr></table> 6 5 4 3 2 1																					P32	OFF <table style="display: inline-table; border-collapse: collapse;"><tr><td style="width: 10px; height: 10px; background-color: white;"></td><td style="width: 10px; height: 10px; background-color: white;"></td><td style="width: 10px; height: 10px; background-color: white;"></td><td style="width: 10px; height: 10px; background-color: white;"></td><td style="width: 10px; height: 10px; background-color: white;"></td><td style="width: 10px; height: 10px; background-color: white;"></td><td style="width: 10px; height: 10px; background-color: white;"></td><td style="width: 10px; height: 10px; background-color: white;"></td><td style="width: 10px; height: 10px; background-color: white;"></td><td style="width: 10px; height: 10px; background-color: white;"></td></tr></table> ON <table style="display: inline-table; border-collapse: collapse;"><tr><td style="width: 10px; height: 10px; background-color: white;"></td><td style="width: 10px; height: 10px; background-color: white;"></td><td style="width: 10px; height: 10px; background-color: white;"></td><td style="width: 10px; height: 10px; background-color: white;"></td><td style="width: 10px; height: 10px; background-color: white;"></td><td style="width: 10px; height: 10px; background-color: white;"></td><td style="width: 10px; height: 10px; background-color: white;"></td><td style="width: 10px; height: 10px; background-color: white;"></td><td style="width: 10px; height: 10px; background-color: white;"></td><td style="width: 10px; height: 10px; background-color: white;"></td></tr></table> 6 5 4 3 2 1																					P20	OFF <table style="display: inline-table; border-collapse: collapse;"><tr><td style="width: 10px; height: 10px; background-color: white;"></td><td style="width: 10px; height: 10px; background-color: white;"></td><td style="width: 10px; height: 10px; background-color: white;"></td><td style="width: 10px; height: 10px; background-color: white;"></td><td style="width: 10px; height: 10px; background-color: white;"></td><td style="width: 10px; height: 10px; background-color: white;"></td><td style="width: 10px; height: 10px; background-color: white;"></td><td style="width: 10px; height: 10px; background-color: white;"></td><td style="width: 10px; height: 10px; background-color: white;"></td><td style="width: 10px; height: 10px; background-color: white;"></td></tr></table> ON <table style="display: inline-table; border-collapse: collapse;"><tr><td style="width: 10px; height: 10px; background-color: white;"></td><td style="width: 10px; height: 10px; background-color: white;"></td><td style="width: 10px; height: 10px; background-color: white;"></td><td style="width: 10px; height: 10px; background-color: white;"></td><td style="width: 10px; height: 10px; background-color: white;"></td><td style="width: 10px; height: 10px; background-color: white;"></td><td style="width: 10px; height: 10px; background-color: white;"></td><td style="width: 10px; height: 10px; background-color: white;"></td><td style="width: 10px; height: 10px; background-color: white;"></td><td style="width: 10px; height: 10px; background-color: white;"></td></tr></table> 6 5 4 3 2 1																					P40	OFF <table style="display: inline-table; border-collapse: collapse;"><tr><td style="width: 10px; height: 10px; background-color: white;"></td><td style="width: 10px; height: 10px; background-color: white;"></td><td style="width: 10px; height: 10px; background-color: white;"></td><td style="width: 10px; height: 10px; background-color: white;"></td><td style="width: 10px; height: 10px; background-color: white;"></td><td style="width: 10px; height: 10px; background-color: white;"></td><td style="width: 10px; height: 10px; background-color: white;"></td><td style="width: 10px; height: 10px; background-color: white;"></td><td style="width: 10px; height: 10px; background-color: white;"></td><td style="width: 10px; height: 10px; background-color: white;"></td></tr></table> ON <table style="display: inline-table; border-collapse: collapse;"><tr><td style="width: 10px; height: 10px; background-color: white;"></td><td style="width: 10px; height: 10px; background-color: white;"></td><td style="width: 10px; height: 10px; background-color: white;"></td><td style="width: 10px; height: 10px; background-color: white;"></td><td style="width: 10px; height: 10px; background-color: white;"></td><td style="width: 10px; height: 10px; background-color: white;"></td><td style="width: 10px; height: 10px; background-color: white;"></td><td style="width: 10px; height: 10px; background-color: white;"></td><td style="width: 10px; height: 10px; background-color: white;"></td><td style="width: 10px; height: 10px; background-color: white;"></td></tr></table> 6 5 4 3 2 1																							P50	OFF <table style="display: inline-table; border-collapse: collapse;"><tr><td style="width: 10px; height: 10px; background-color: white;"></td><td style="width: 10px; height: 10px; background-color: white;"></td><td style="width: 10px; height: 10px; background-color: white;"></td><td style="width: 10px; height: 10px; background-color: white;"></td><td style="width: 10px; height: 10px; background-color: white;"></td><td style="width: 10px; height: 10px; background-color: white;"></td><td style="width: 10px; height: 10px; background-color: white;"></td><td style="width: 10px; height: 10px; background-color: white;"></td><td style="width: 10px; height: 10px; background-color: white;"></td><td style="width: 10px; height: 10px; background-color: white;"></td></tr></table> ON <table style="display: inline-table; border-collapse: collapse;"><tr><td style="width: 10px; height: 10px; background-color: white;"></td><td style="width: 10px; height: 10px; background-color: white;"></td><td style="width: 10px; height: 10px; background-color: white;"></td><td style="width: 10px; height: 10px; background-color: white;"></td><td style="width: 10px; height: 10px; background-color: white;"></td><td style="width: 10px; height: 10px; background-color: white;"></td><td style="width: 10px; height: 10px; background-color: white;"></td><td style="width: 10px; height: 10px; background-color: white;"></td><td style="width: 10px; height: 10px; background-color: white;"></td><td style="width: 10px; height: 10px; background-color: white;"></td></tr></table> 6 5 4 3 2 1																					Before power supply ON	<div style="border: 1px solid black; padding: 2px; width: fit-content; margin-bottom: 5px;">Indoor controller board</div> <Initial setting> Set for each capacity.
		Models	SW2	Models	SW2																																																																																																																																																															
		P10	OFF <table style="display: inline-table; border-collapse: collapse;"><tr><td style="width: 10px; height: 10px; background-color: white;"></td><td style="width: 10px; height: 10px; background-color: black;"></td><td style="width: 10px; height: 10px; background-color: white;"></td><td style="width: 10px; height: 10px; background-color: white;"></td><td style="width: 10px; height: 10px; background-color: white;"></td><td style="width: 10px; height: 10px; background-color: white;"></td><td style="width: 10px; height: 10px; background-color: white;"></td><td style="width: 10px; height: 10px; background-color: white;"></td><td style="width: 10px; height: 10px; background-color: white;"></td><td style="width: 10px; height: 10px; background-color: white;"></td></tr></table> ON <table style="display: inline-table; border-collapse: collapse;"><tr><td style="width: 10px; height: 10px; background-color: white;"></td><td style="width: 10px; height: 10px; background-color: white;"></td><td style="width: 10px; height: 10px; background-color: white;"></td><td style="width: 10px; height: 10px; background-color: white;"></td><td style="width: 10px; height: 10px; background-color: white;"></td><td style="width: 10px; height: 10px; background-color: white;"></td><td style="width: 10px; height: 10px; background-color: white;"></td><td style="width: 10px; height: 10px; background-color: white;"></td><td style="width: 10px; height: 10px; background-color: white;"></td><td style="width: 10px; height: 10px; background-color: white;"></td></tr></table> 6 5 4 3 2 1																					P25	OFF <table style="display: inline-table; border-collapse: collapse;"><tr><td style="width: 10px; height: 10px; background-color: white;"></td><td style="width: 10px; height: 10px; background-color: black;"></td><td style="width: 10px; height: 10px; background-color: white;"></td><td style="width: 10px; height: 10px; background-color: white;"></td><td style="width: 10px; height: 10px; background-color: white;"></td><td style="width: 10px; height: 10px; background-color: white;"></td><td style="width: 10px; height: 10px; background-color: white;"></td><td style="width: 10px; height: 10px; background-color: white;"></td><td style="width: 10px; height: 10px; background-color: white;"></td><td style="width: 10px; height: 10px; background-color: white;"></td></tr></table> ON <table style="display: inline-table; border-collapse: collapse;"><tr><td style="width: 10px; height: 10px; background-color: white;"></td><td style="width: 10px; height: 10px; background-color: white;"></td><td style="width: 10px; height: 10px; background-color: white;"></td><td style="width: 10px; height: 10px; background-color: white;"></td><td style="width: 10px; height: 10px; background-color: white;"></td><td style="width: 10px; height: 10px; background-color: white;"></td><td style="width: 10px; height: 10px; background-color: white;"></td><td style="width: 10px; height: 10px; background-color: white;"></td><td style="width: 10px; height: 10px; background-color: white;"></td><td style="width: 10px; height: 10px; background-color: white;"></td></tr></table> 6 5 4 3 2 1																																																																																																																																											
P15	OFF <table style="display: inline-table; border-collapse: collapse;"><tr><td style="width: 10px; height: 10px; background-color: white;"></td><td style="width: 10px; height: 10px; background-color: white;"></td><td style="width: 10px; height: 10px; background-color: white;"></td><td style="width: 10px; height: 10px; background-color: white;"></td><td style="width: 10px; height: 10px; background-color: white;"></td><td style="width: 10px; height: 10px; background-color: white;"></td><td style="width: 10px; height: 10px; background-color: white;"></td><td style="width: 10px; height: 10px; background-color: white;"></td><td style="width: 10px; height: 10px; background-color: white;"></td><td style="width: 10px; height: 10px; background-color: white;"></td></tr></table> ON <table style="display: inline-table; border-collapse: collapse;"><tr><td style="width: 10px; height: 10px; background-color: white;"></td><td style="width: 10px; height: 10px; background-color: white;"></td><td style="width: 10px; height: 10px; background-color: white;"></td><td style="width: 10px; height: 10px; background-color: white;"></td><td style="width: 10px; height: 10px; background-color: white;"></td><td style="width: 10px; height: 10px; background-color: white;"></td><td style="width: 10px; height: 10px; background-color: white;"></td><td style="width: 10px; height: 10px; background-color: white;"></td><td style="width: 10px; height: 10px; background-color: white;"></td><td style="width: 10px; height: 10px; background-color: white;"></td></tr></table> 6 5 4 3 2 1																					P32	OFF <table style="display: inline-table; border-collapse: collapse;"><tr><td style="width: 10px; height: 10px; background-color: white;"></td><td style="width: 10px; height: 10px; background-color: white;"></td><td style="width: 10px; height: 10px; background-color: white;"></td><td style="width: 10px; height: 10px; background-color: white;"></td><td style="width: 10px; height: 10px; background-color: white;"></td><td style="width: 10px; height: 10px; background-color: white;"></td><td style="width: 10px; height: 10px; background-color: white;"></td><td style="width: 10px; height: 10px; background-color: white;"></td><td style="width: 10px; height: 10px; background-color: white;"></td><td style="width: 10px; height: 10px; background-color: white;"></td></tr></table> ON <table style="display: inline-table; border-collapse: collapse;"><tr><td style="width: 10px; height: 10px; background-color: white;"></td><td style="width: 10px; height: 10px; background-color: white;"></td><td style="width: 10px; height: 10px; background-color: white;"></td><td style="width: 10px; height: 10px; background-color: white;"></td><td style="width: 10px; height: 10px; background-color: white;"></td><td style="width: 10px; height: 10px; background-color: white;"></td><td style="width: 10px; height: 10px; background-color: white;"></td><td style="width: 10px; height: 10px; background-color: white;"></td><td style="width: 10px; height: 10px; background-color: white;"></td><td style="width: 10px; height: 10px; background-color: white;"></td></tr></table> 6 5 4 3 2 1																																																																																																																																													
P20	OFF <table style="display: inline-table; border-collapse: collapse;"><tr><td style="width: 10px; height: 10px; background-color: white;"></td><td style="width: 10px; height: 10px; background-color: white;"></td><td style="width: 10px; height: 10px; background-color: white;"></td><td style="width: 10px; height: 10px; background-color: white;"></td><td style="width: 10px; height: 10px; background-color: white;"></td><td style="width: 10px; height: 10px; background-color: white;"></td><td style="width: 10px; height: 10px; background-color: white;"></td><td style="width: 10px; height: 10px; background-color: white;"></td><td style="width: 10px; height: 10px; background-color: white;"></td><td style="width: 10px; height: 10px; background-color: white;"></td></tr></table> ON <table style="display: inline-table; border-collapse: collapse;"><tr><td style="width: 10px; height: 10px; background-color: white;"></td><td style="width: 10px; height: 10px; background-color: white;"></td><td style="width: 10px; height: 10px; background-color: white;"></td><td style="width: 10px; height: 10px; background-color: white;"></td><td style="width: 10px; height: 10px; background-color: white;"></td><td style="width: 10px; height: 10px; background-color: white;"></td><td style="width: 10px; height: 10px; background-color: white;"></td><td style="width: 10px; height: 10px; background-color: white;"></td><td style="width: 10px; height: 10px; background-color: white;"></td><td style="width: 10px; height: 10px; background-color: white;"></td></tr></table> 6 5 4 3 2 1																					P40	OFF <table style="display: inline-table; border-collapse: collapse;"><tr><td style="width: 10px; height: 10px; background-color: white;"></td><td style="width: 10px; height: 10px; background-color: white;"></td><td style="width: 10px; height: 10px; background-color: white;"></td><td style="width: 10px; height: 10px; background-color: white;"></td><td style="width: 10px; height: 10px; background-color: white;"></td><td style="width: 10px; height: 10px; background-color: white;"></td><td style="width: 10px; height: 10px; background-color: white;"></td><td style="width: 10px; height: 10px; background-color: white;"></td><td style="width: 10px; height: 10px; background-color: white;"></td><td style="width: 10px; height: 10px; background-color: white;"></td></tr></table> ON <table style="display: inline-table; border-collapse: collapse;"><tr><td style="width: 10px; height: 10px; background-color: white;"></td><td style="width: 10px; height: 10px; background-color: white;"></td><td style="width: 10px; height: 10px; background-color: white;"></td><td style="width: 10px; height: 10px; background-color: white;"></td><td style="width: 10px; height: 10px; background-color: white;"></td><td style="width: 10px; height: 10px; background-color: white;"></td><td style="width: 10px; height: 10px; background-color: white;"></td><td style="width: 10px; height: 10px; background-color: white;"></td><td style="width: 10px; height: 10px; background-color: white;"></td><td style="width: 10px; height: 10px; background-color: white;"></td></tr></table> 6 5 4 3 2 1																																																																																																																																													
		P50	OFF <table style="display: inline-table; border-collapse: collapse;"><tr><td style="width: 10px; height: 10px; background-color: white;"></td><td style="width: 10px; height: 10px; background-color: white;"></td><td style="width: 10px; height: 10px; background-color: white;"></td><td style="width: 10px; height: 10px; background-color: white;"></td><td style="width: 10px; height: 10px; background-color: white;"></td><td style="width: 10px; height: 10px; background-color: white;"></td><td style="width: 10px; height: 10px; background-color: white;"></td><td style="width: 10px; height: 10px; background-color: white;"></td><td style="width: 10px; height: 10px; background-color: white;"></td><td style="width: 10px; height: 10px; background-color: white;"></td></tr></table> ON <table style="display: inline-table; border-collapse: collapse;"><tr><td style="width: 10px; height: 10px; background-color: white;"></td><td style="width: 10px; height: 10px; background-color: white;"></td><td style="width: 10px; height: 10px; background-color: white;"></td><td style="width: 10px; height: 10px; background-color: white;"></td><td style="width: 10px; height: 10px; background-color: white;"></td><td style="width: 10px; height: 10px; background-color: white;"></td><td style="width: 10px; height: 10px; background-color: white;"></td><td style="width: 10px; height: 10px; background-color: white;"></td><td style="width: 10px; height: 10px; background-color: white;"></td><td style="width: 10px; height: 10px; background-color: white;"></td></tr></table> 6 5 4 3 2 1																																																																																																																																																																	
SW3 Function Selection	1	Heat pump/Cool only	Cooling only	Heat pump	Under suspension	<div style="border: 1px solid black; padding: 2px; width: fit-content; margin-bottom: 5px;">Indoor controller board</div> <Initial setting> ON <table style="display: inline-table; border-collapse: collapse;"><tr><td style="width: 10px; height: 10px; background-color: white;"></td><td style="width: 10px; height: 10px; background-color: white;"></td><td style="width: 10px; height: 10px; background-color: white;"></td><td style="width: 10px; height: 10px; background-color: white;"></td><td style="width: 10px; height: 10px; background-color: white;"></td><td style="width: 10px; height: 10px; background-color: white;"></td><td style="width: 10px; height: 10px; background-color: white;"></td><td style="width: 10px; height: 10px; background-color: white;"></td><td style="width: 10px; height: 10px; background-color: white;"></td><td style="width: 10px; height: 10px; background-color: white;"></td></tr></table> OFF <table style="display: inline-table; border-collapse: collapse;"><tr><td style="width: 10px; height: 10px; background-color: black;"></td><td style="width: 10px; height: 10px; background-color: black;"></td><td style="width: 10px; height: 10px; background-color: black;"></td><td style="width: 10px; height: 10px; background-color: black;"></td><td style="width: 10px; height: 10px; background-color: black;"></td><td style="width: 10px; height: 10px; background-color: black;"></td><td style="width: 10px; height: 10px; background-color: black;"></td><td style="width: 10px; height: 10px; background-color: black;"></td><td style="width: 10px; height: 10px; background-color: black;"></td><td style="width: 10px; height: 10px; background-color: black;"></td></tr></table> 1 2 3 4 5 6 7 8 9 0																																																																																																																																																														
	2	—	—	—																																																																																																																																																																
	3	—	—	—																																																																																																																																																																
	4	—	—	—																																																																																																																																																																
	5	—	—	—																																																																																																																																																																
	6	—	—	—																																																																																																																																																																
	7	Changing the opening of linear expansion valve	Effective	Not effective																																																																																																																																																																
	8	Heating 4 degree up	Not effective	Effective																																																																																																																																																																
9	—	—	—																																																																																																																																																																	
10	—	—	—																																																																																																																																																																	

<Table A>

SW1-7	SW1-8	
OFF	OFF	Extra low
ON	OFF	Low
OFF	ON	Setting air flow
ON	ON	stop

Continue to the next page

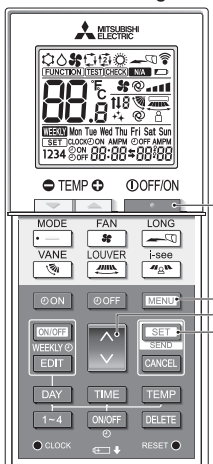
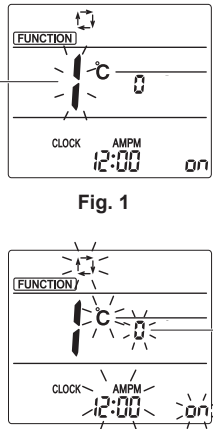
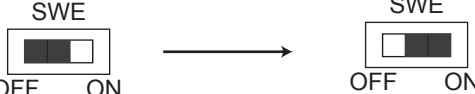
The black square (■) indicates a switch position.

Switch	Pole	Function	Effective timing	Remarks																																			
SWA (Fan speed)	1~3	 <p>Fan speed can be changed depending on SWA setting.</p> <table border="1" data-bbox="560 413 971 476"> <tr> <td>PKFY-P**VLM-(E/ET)</td> <td>Setting</td> </tr> <tr> <td></td> <td>2</td> </tr> </table> <p>When using MAC2471FT-E, change SWA from 2 to 3</p>	PKFY-P**VLM-(E/ET)	Setting		2	Under operation or suspension	<div style="border: 1px solid black; padding: 2px;">Address board</div> <p>&lt;Initial setting&gt; It follows as the left table.</p>																															
PKFY-P**VLM-(E/ET)	Setting																																						
	2																																						
SW11 1s digit address setting  SW12 10s digit address setting	Rotary switch	  <p>Address setting should be done when M-NET remote controller is being used.</p>	Before power supply ON	<div style="border: 1px solid black; padding: 2px;">Address board</div> <p>&lt;Initial setting&gt;</p> 																																			
SW14 Connection No. setting	Rotary switch	 <p>This is the switch to be used when the indoor unit is operated with R2 series outdoor unit as a set.</p>		<div style="border: 1px solid black; padding: 2px;">Address board</div> <p>&lt;Initial setting&gt;</p> 																																			
SW22 Function selection	Jumper	<table border="1" data-bbox="332 976 950 1127"> <thead> <tr> <th>Function</th> <th>ON</th> <th>OFF</th> </tr> </thead> <tbody> <tr> <td>1</td> <td>—</td> <td>—</td> </tr> <tr> <td>2</td> <td>—</td> <td>—</td> </tr> <tr> <td>3 Pair No. of wireless remote controller</td> <td colspan="2" rowspan="2">Depends on SW22-3, 22-4</td> </tr> <tr> <td>4 Pair No. of wireless remote controller</td> </tr> </tbody> </table> <ul style="list-style-type: none"> <li>To operate each indoor unit by each remote controller when installed 2 indoor units or more are near, Pair No. setting is necessary. <ul style="list-style-type: none"> <li>Pair No. setting is available with the 4 patterns (Setting patterns A to D).</li> </ul> </li> <li>You may not set it when operating it by one remote controller. Setting for indoor unit.</li> </ul> <p>Wireless remote controller pair number:</p> <ul style="list-style-type: none"> <li>Setting operation (Fig. 1 (A)) <ol style="list-style-type: none"> <li>Press the  button ① to stop the air conditioner.</li> <li>Press the  button ②.</li> <li>Check that function No."1" is displayed, and then press the  button ③. The Screen display setting screen will be displayed. (Fig. 2.)</li> </ol> </li> <li>Pair No. changing operation (Fig. 2 (B)) <ol style="list-style-type: none"> <li>Press the  button ④.</li> <li>Each time the  button ④ is pressed, the pair No.0-3 changes.</li> <li>Press the  button ③ to check the setting.</li> <li>Press the  button ②.</li> </ol> </li> </ul> <table border="1" data-bbox="332 1615 941 1789"> <thead> <tr> <th colspan="2">Indoor unit SW22</th> <th rowspan="2">Pair No. of wireless remote controller</th> <th rowspan="2">Initial setting</th> </tr> <tr> <th>SW22-3</th> <th>SW22-4</th> </tr> </thead> <tbody> <tr> <td>ON</td> <td>ON</td> <td>0</td> <td>Initial setting</td> </tr> <tr> <td>OFF</td> <td>ON</td> <td>1</td> <td>—</td> </tr> <tr> <td>ON</td> <td>OFF</td> <td>2</td> <td>—</td> </tr> <tr> <td>OFF</td> <td>OFF</td> <td>3-9</td> <td>—</td> </tr> </tbody> </table>	Function	ON	OFF	1	—	—	2	—	—	3 Pair No. of wireless remote controller	Depends on SW22-3, 22-4		4 Pair No. of wireless remote controller	Indoor unit SW22		Pair No. of wireless remote controller	Initial setting	SW22-3	SW22-4	ON	ON	0	Initial setting	OFF	ON	1	—	ON	OFF	2	—	OFF	OFF	3-9	—	Under operation or suspension	<p>&lt;Initial setting&gt;</p>   <p>Fig. 1</p> <p>Fig. 2</p>
Function	ON	OFF																																					
1	—	—																																					
2	—	—																																					
3 Pair No. of wireless remote controller	Depends on SW22-3, 22-4																																						
4 Pair No. of wireless remote controller																																							
Indoor unit SW22		Pair No. of wireless remote controller	Initial setting																																				
SW22-3	SW22-4																																						
ON	ON	0	Initial setting																																				
OFF	ON	1	—																																				
ON	OFF	2	—																																				
OFF	OFF	3-9	—																																				
SWE Test run for Drain pump	Connector	<p>Drain pump and fan are activated simultaneously after the connector SWE is set to ON and turn on the power.</p>  <p>The connector SWE is set to OFF after test run.</p>	Under operation	<p>&lt;Initial setting&gt;</p> 																																			

## 8-3. TEST POINT DIAGRAM

### 8-3-1. Indoor controller board (I.B)

PKFY-P10VLM-(ER1/ETR1).TH  
 PKFY-P20VLM-(ER1/ETR1).TH  
 PKFY-P32VLM-(ER1/ETR1).TH  
 PKFY-P50VLM-(ER1/ETR1).TH

PKFY-P15VLM-(ER1/ETR1).TH  
 PKFY-P25VLM-(ER1/ETR1).TH  
 PKFY-P40VLM-(ER1/ETR1).TH

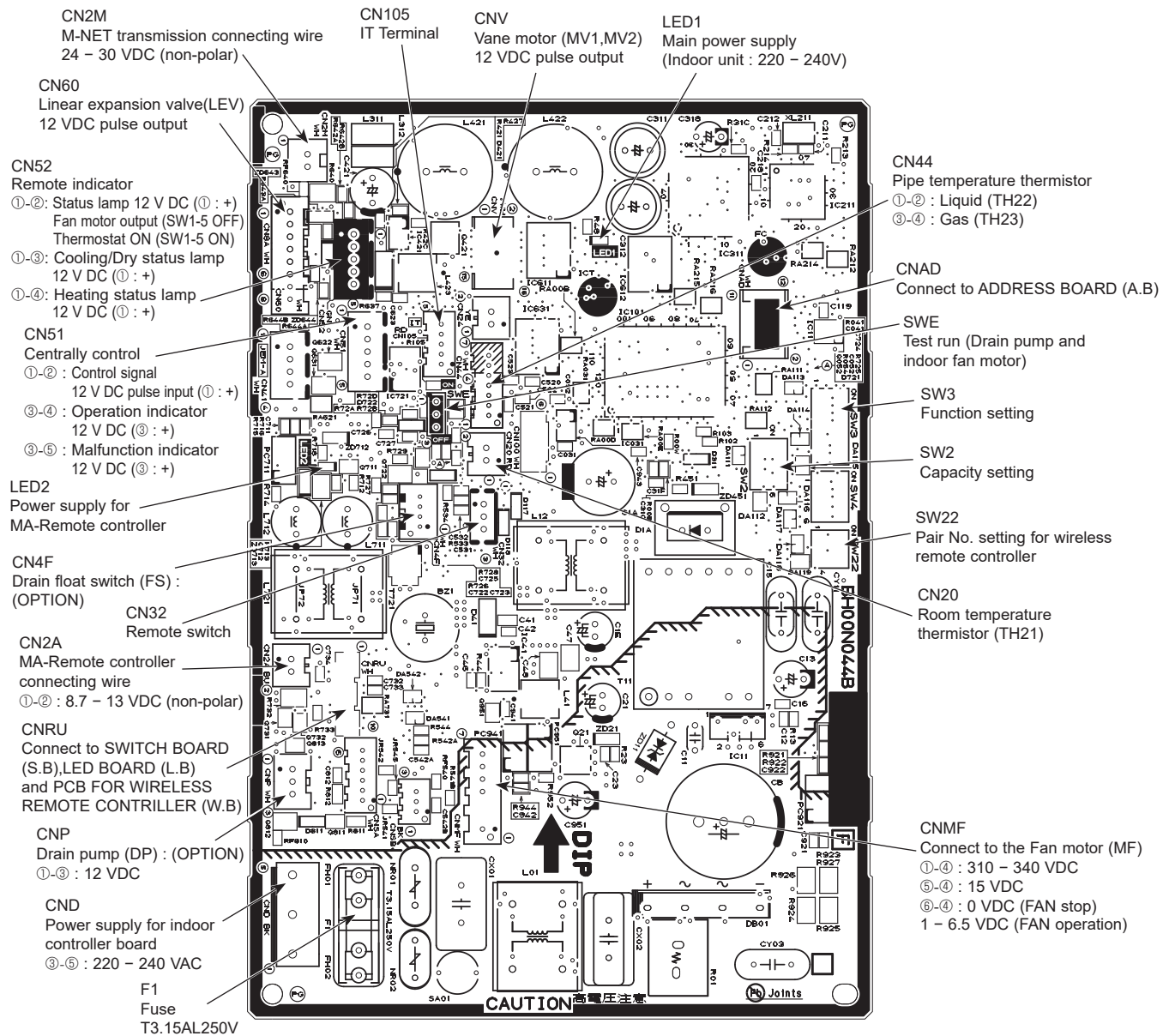

Note: The voltage range of 12 V DC in this page is between 11.5 to 13.7 V DC.

**8-3-2. PCB FOR WIRELESS REMOTE CONTROLLER (W.B),  
SWITCH BOARD (S.B) and LED BOARD (L.B)**

PKFY-P10VLM-(ER1/ETR1).TH  
 PKFY-P20VLM-(ER1/ETR1).TH  
 PKFY-P32VLM-(ER1/ETR1).TH  
 PKFY-P50VLM-(ER1/ETR1).TH

PKFY-P15VLM-(ER1/ETR1).TH  
 PKFY-P25VLM-(ER1/ETR1).TH  
 PKFY-P40VLM-(ER1/ETR1).TH

**PCB FOR WIRELESS  
REMOTE CONTROLLER (W.B)**

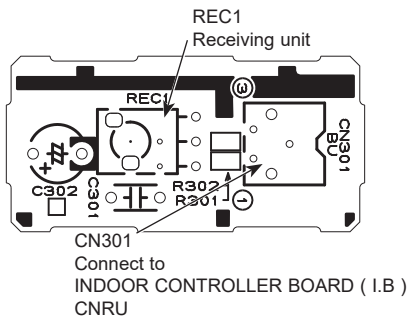

**SWITCH BOARD (S.B)**

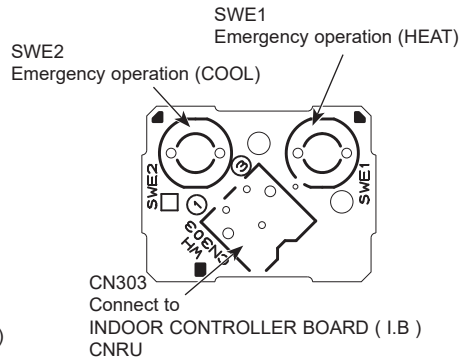

**LED BOARD (L.B)**

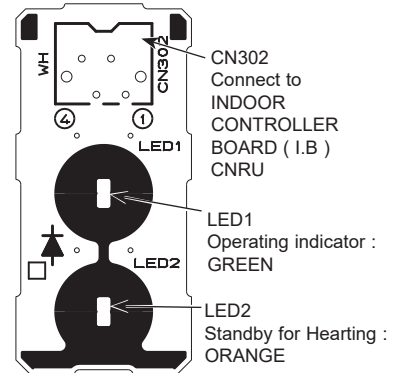

**8-3-3. Address board (A.B)**

PKFY-P10VLM-(ER1/ETR1).TH  
 PKFY-P20VLM-(ER1/ETR1).TH  
 PKFY-P32VLM-(ER1/ETR1).TH  
 PKFY-P50VLM-(ER1/ETR1).TH

PKFY-P15VLM-(ER1/ETR1).TH  
 PKFY-P25VLM-(ER1/ETR1).TH  
 PKFY-P40VLM-(ER1/ETR1).TH

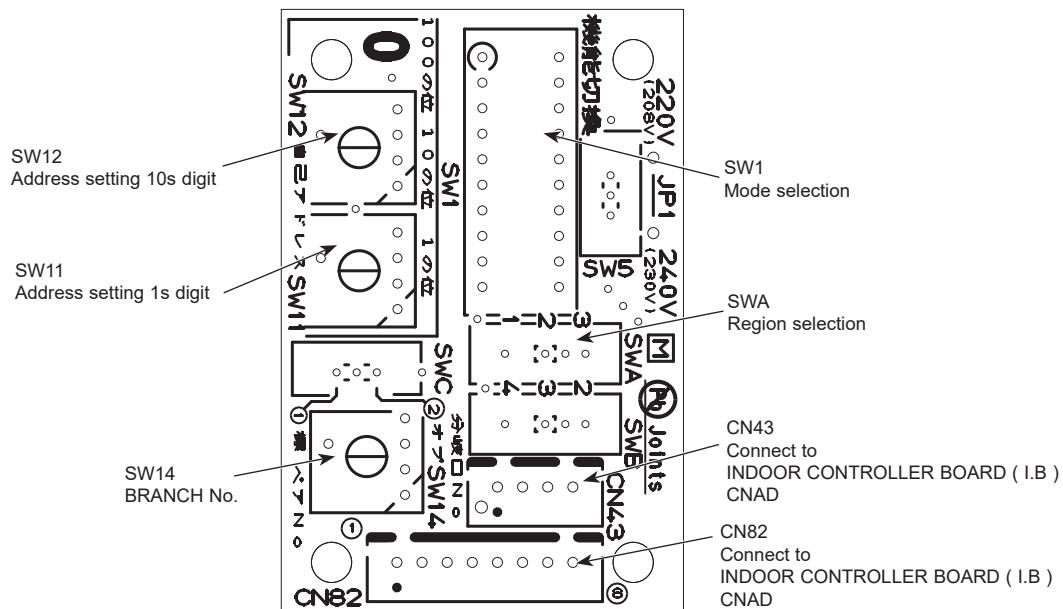

PKFY-P10VLM-(ER1/ETR1).TH  
 PKFY-P20VLM-(ER1/ETR1).TH  
 PKFY-P32VLM-(ER1/ETR1).TH  
 PKFY-P50VLM-(ER1/ETR1).TH

PKFY-P15VLM-(ER1/ETR1).TH  
 PKFY-P25VLM-(ER1/ETR1).TH  
 PKFY-P40VLM-(ER1/ETR1).TH

NOTE: Turn OFF the power supply before assembly.

Be careful when removing heavy parts.

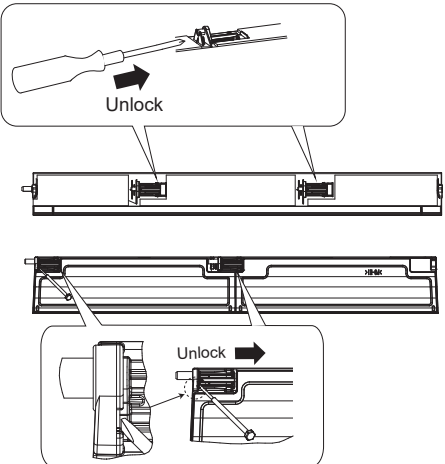
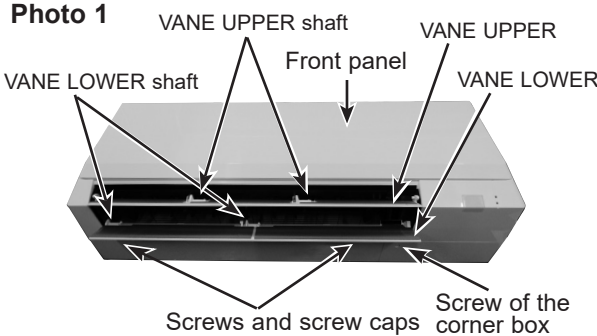
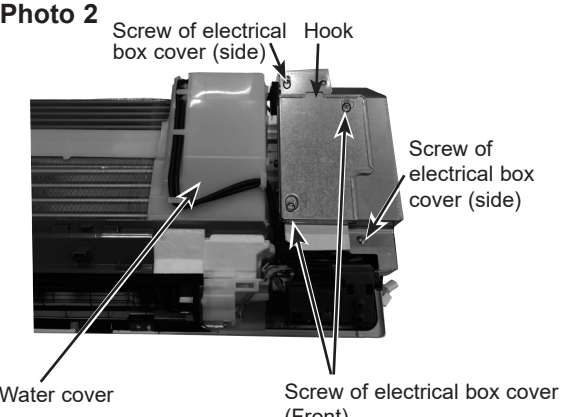
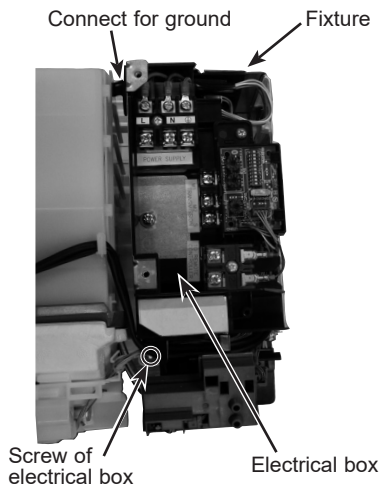
OPERATION PROCEDURE	PHOTOS/FIGURES
<p><b>1. REMOVING THE PANEL</b></p> <ol style="list-style-type: none"> <li>(1) Insert the driver to the hole at VANE LOWER shaft and slide the VANE LOWER shaft (2 places each). Push VANE UPPER shaft with the driver.</li> <li>(2) Pull the VANE LOWER and VANE UPPER from unit.</li> <li>(3) Remove 2 screw caps of the front panel. Remove 2 screws. (See Photo 1)</li> <li>(4) Hold the lower part of both ends of the front panel and pull it slightly toward you, and then remove the front panel by pushing it upward.</li> <li>(5) Remove the screw of the corner box. (See Photo 1) Remove the corner box.</li> </ol> <div style="border: 1px solid black; padding: 5px; margin: 10px 0;"> <p>Unlock the stopper and remove the horizontal vanes using following tool like a screw driver.</p>  </div>	<p><b>Photo 1</b></p>  <p><b>Photo 2</b></p> 
<p><b>2. REMOVING THE ELECTRICAL BOX</b></p> <ol style="list-style-type: none"> <li>(1) Remove the panel and the corner box. (Refer procedure to 1)</li> <li>(2) Remove the front and side electrical box covers (each 2 screw).</li> <li>(3) Remove the transmission wiring of TB5, the power supply wiring of TB2 and the wiring of MA-remote controller (TB15).</li> <li>(4) Disconnect the connectors on the indoor controller board.</li> <li>(5) Disconnect the connector for ground wire.</li> <li>(6) Remove the screw on lower side of the electrical box. (See Photo 3)</li> <li>(7) Push up the upper fixture catch to remove the box, then remove it from the box fixture.</li> </ol>	<p><b>Photo 3</b></p> 

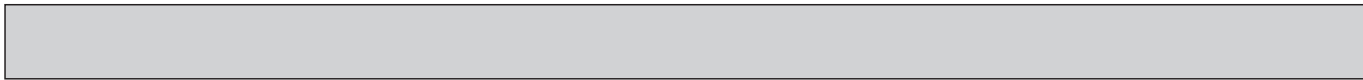

**OPERATION PROCEDURE**

**3. REMOVING THE ADDRESS BOARD, THE INDOOR CONTROLLER BOARD, THE WIRELESS CONTROLLER BOARD, LED BOARD**

- (1) Remove the panel and the corner box. (Refer to procedure 1)
- (2) Remove the front and side electrical box covers (each 2 screw).
- (3) Disconnect the connectors of address board.
- (4) Disconnect the connectors on the indoor controller board. (See Photo 4)
- (5) Remove the switch board holder and open the cover.
- (6) Pull out the indoor controller board toward you then remove the indoor controller board and switch board. (See Photo 4)
- (7) Remove the holder of wireless remote controller board and LED board.
- (8) Disconnect the connector of wireless remote controller board and LED board.
- (9) Remove the wireless remote controller board and LED board from the holder.

**4. REMOVING THE NOZZLE ASSEMBLY (with VANE and VANE MOTOR) AND DRAIN HOSE**

- (1) Remove the panel and corner box. (Refer to procedure 1)
- (2) Remove the electrical box covers. (Refer to procedure 2)
- (3) Disconnect the vane motor connector (CNV) on the indoor controller board.
- (4) Push fixture and pull out the drain hose from the nozzle assembly, and remove nozzle assembly. (See Photo 6)

**5. REMOVING THE VANE MOTOR**

- (1) Remove the nozzle assembly. (Refer to procedure 4)
- (2) Remove 2 screws of the vane motor unit cover, and pull out the vane motor unit.
- (3) Remove screw of the vane motor (LOWER).
- (4) Remove the vane motor (LOWER) from the vane motor unit cover.
- (5) Disconnect the connector (white) from the vane motor. (LOWER)
- (6) Remove 2 screw of the vane motor (UPPER).
- (7) Remove the vane motor (UPPER) from the vane motor unit cover.
- (8) Disconnect the connector (blue) from the vane motor (UPPER).

**PHOTOS/FIGURES**

**Photo 4**

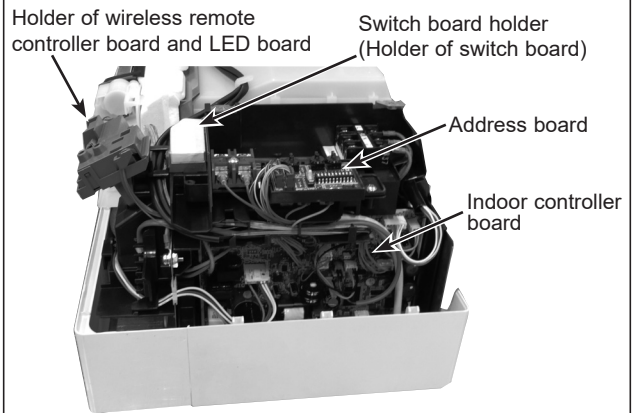

**Photo 5** (see the bottom)

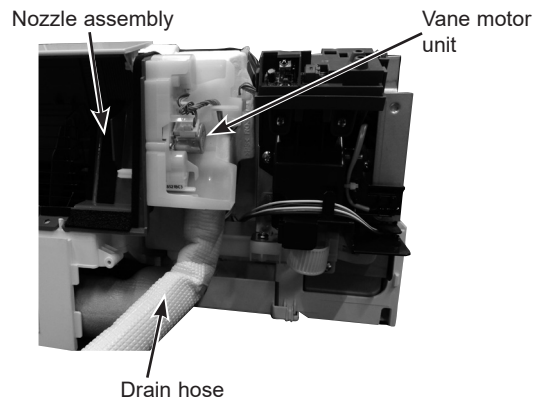

**Photo 6**

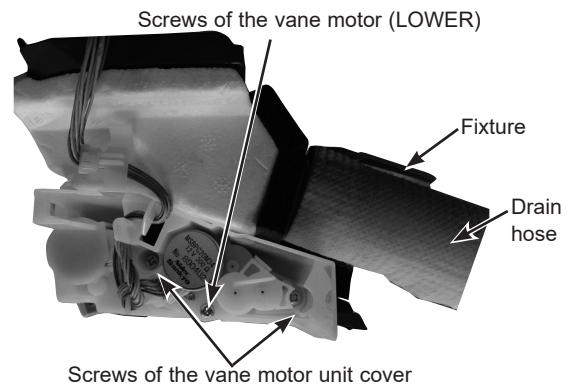

**Photo 7**

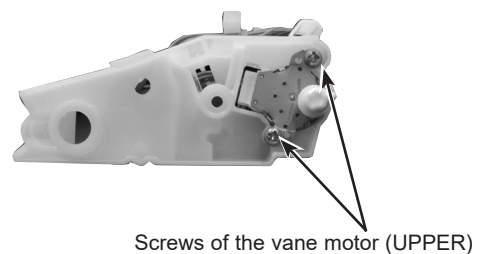



## OPERATION PROCEDURE

### 6. REMOVING THE INDOOR FAN MOTOR AND THE LINE FLOW FAN

- (1) Remove the panel and the corner box. (Refer to procedure 1)
- (2) Remove the electrical box (Refer to procedure 2) and the nozzle assembly (Refer to procedure 4).
- (3) Remove the water cover. (See Photo 2)
- (4) Loosen the screw fixing the line flow fan. (See Photo 9)
- (5) Remove 3 screws fixing the motor bed. (See Photo 8)
- (6) Remove the motor bed together with fan motor and motor band.
- (7) Release the 2 hooks of the motor band. Remove the motor band. Pull out the indoor fan motor.
- (8) Remove 2 screws fixing the left side of the heat exchanger. (See Photo 10)
- (9) Lift the heat exchanger, and pull out the line flow fan to the lower-left.

\* When attaching the line flow fan, screw the line flow fan so 4mm gap is provided between the right end of the line flow fan and the right wall of the air passage of the box. (Photo 9)

**Photo 10**

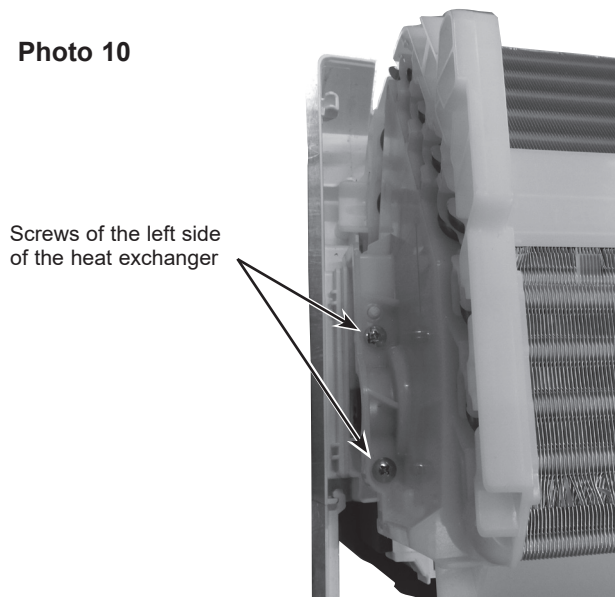

Screws of the left side of the heat exchanger

### 7. REMOVING THE LIQUID PIPE THERMISTOR AND GAS PIPE THERMISTOR

- (1) Remove the panel and the corner box. (Refer to procedure 1)
- (2) Remove the electrical box covers. (Refer to procedure 2)
- (3) Remove the water cover. (See Photo 2)
- (4) Remove the liquid pipe thermistor and gas pipe thermistors.
- (5) Disconnect the connector (CN44) on the indoor controller board. (TH22 and TH23/CN44)

## PHOTOS/FIGURES

**Photo 8**

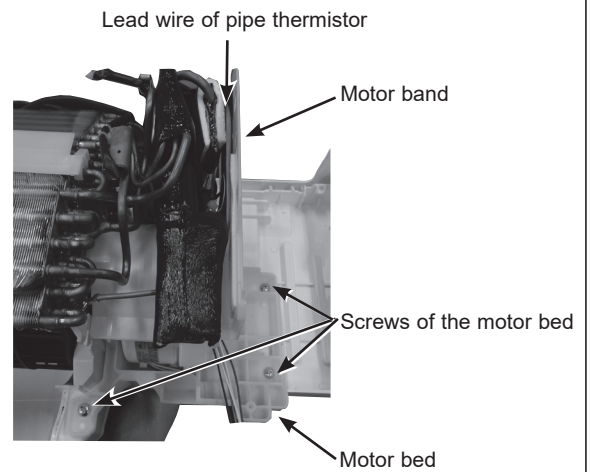

**Photo 9**

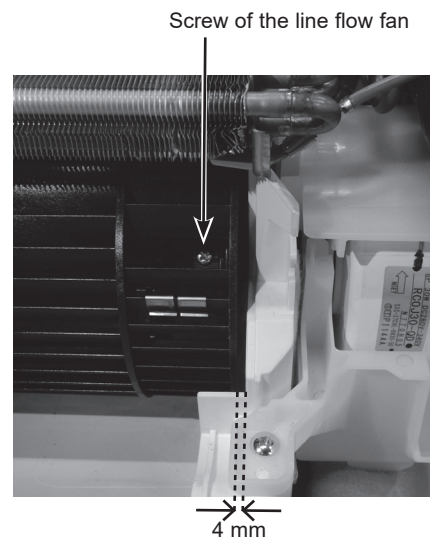

Screw of the line flow fan

4 mm

**Photo 11**

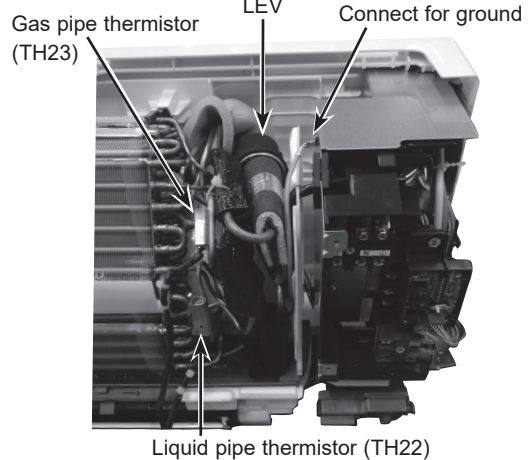

Gas pipe thermistor (TH23)

LEV

Connect for ground (TH22)

Liquid pipe thermistor (TH22)

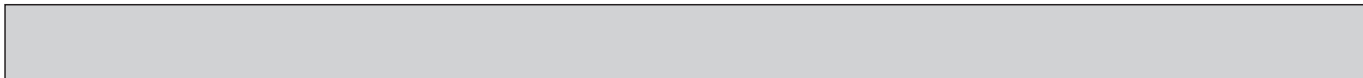

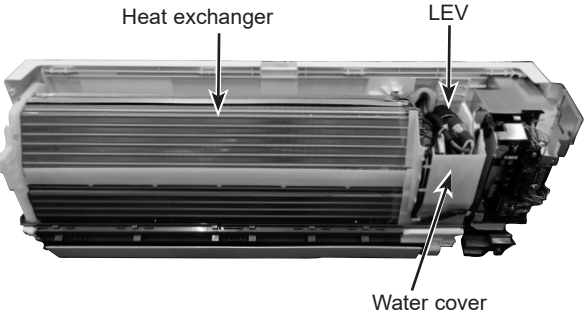
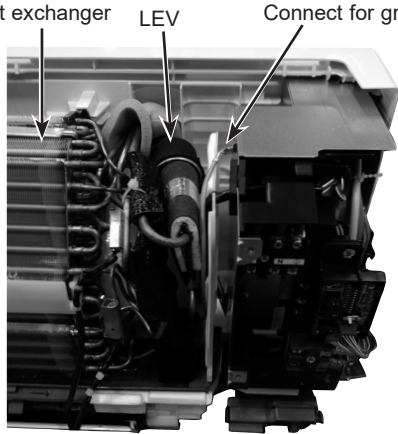
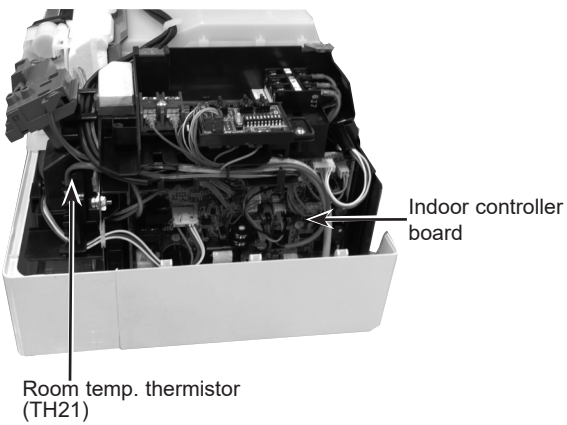
OPERATION PROCEDURE	PHOTOS/FIGURES
<p><b>8. REMOVING THE HEAT EXCHANGER AND LEV</b></p> <ol style="list-style-type: none"><li>(1) Remove the panel and the corner box (Refer to procedure 1).</li><li>(2) Remove the electrical box (Refer to procedure 3) and the nozzle assembly (Refer to procedure 4).</li><li>(3) Remove the water cover.</li><li>(4) Remove the pipe thermistors. (Refer to procedure 7).</li><li>(5) Disconnect the connector (CN60) on the indoor controller board.</li><li>(6) Remove the motor bed together with fan motor and motor band (Refer to procedure 6).</li><li>(7) Remove 2 screws fixing the left side of the heat exchanger. (See Photo 10)</li><li>(8) Remove the heat exchanger with LEV.</li></ol>	<p><b>Photo 12</b></p>  <p><b>Photo 13</b></p> 
<p><b>9. REMOVING THE ROOM TEMPERATURE THERMISTOR</b></p> <ol style="list-style-type: none"><li>(1) Remove the panel and corner box. (Refer to procedure 1)</li><li>(2) Remove the electrical box covers. (Refer to procedure 2)</li><li>(3) Remove the room temperature thermistor.</li><li>(4) Disconnect the connector (CN20) on the indoor controller board.</li></ol>	<p><b>Photo 14</b></p> 





# **mitsubishi electric corporation**

HEAD OFFICE : TOKYO BUILDING, 2-7-3, MARUNOUCHI, CHIYODA-KU TOKYO 100-8310, JAPAN

---

**MITSUBISHI ELECTRIC CONSUMER PRODUCTS (THAILAND) CO., LTD.**  
**700/406 MOO 7, TAMBON DON HUA ROH,**  
**AMPHUR MUANG, CHONBURI 20000 THAILAND**  
**Published: Oct. 2021. No. TCH071**  
**Made in Thailand**

Specifications are subject to change without notice.