

PKFY-MS10, 15, 20, 25, 32VLM-E

Unit: mm

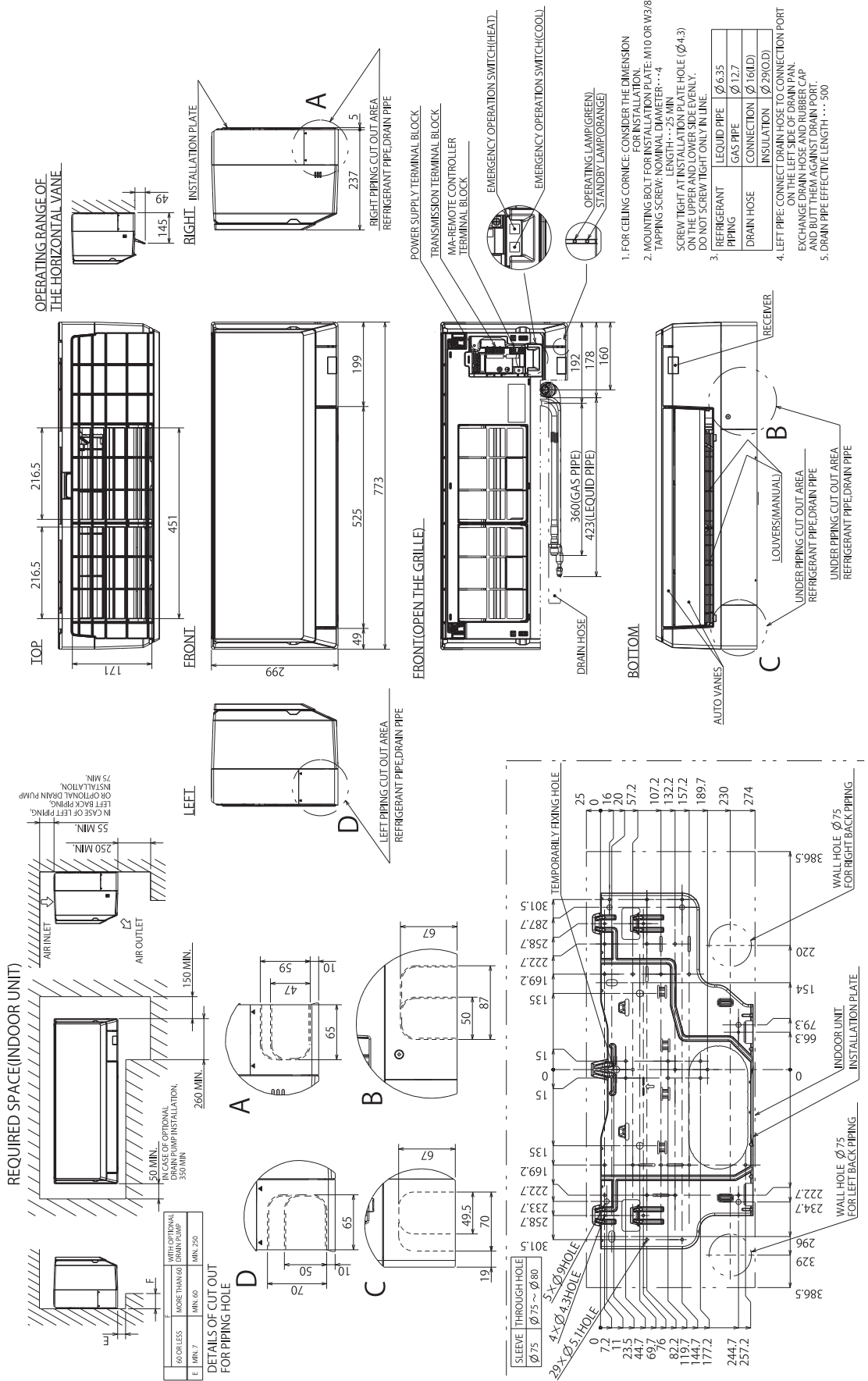

PKFY-MS-VLM-E, VKM-E

PKFY-MS40, 50VLM-E

Unit: mm

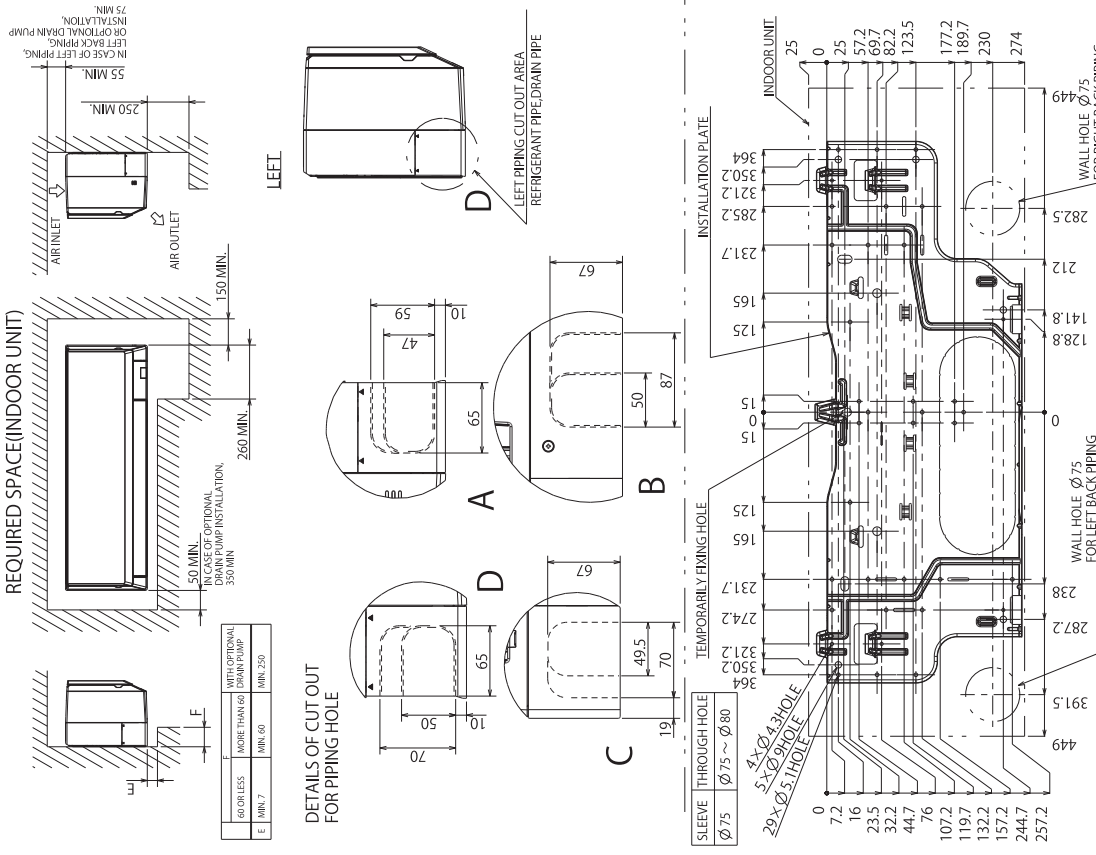
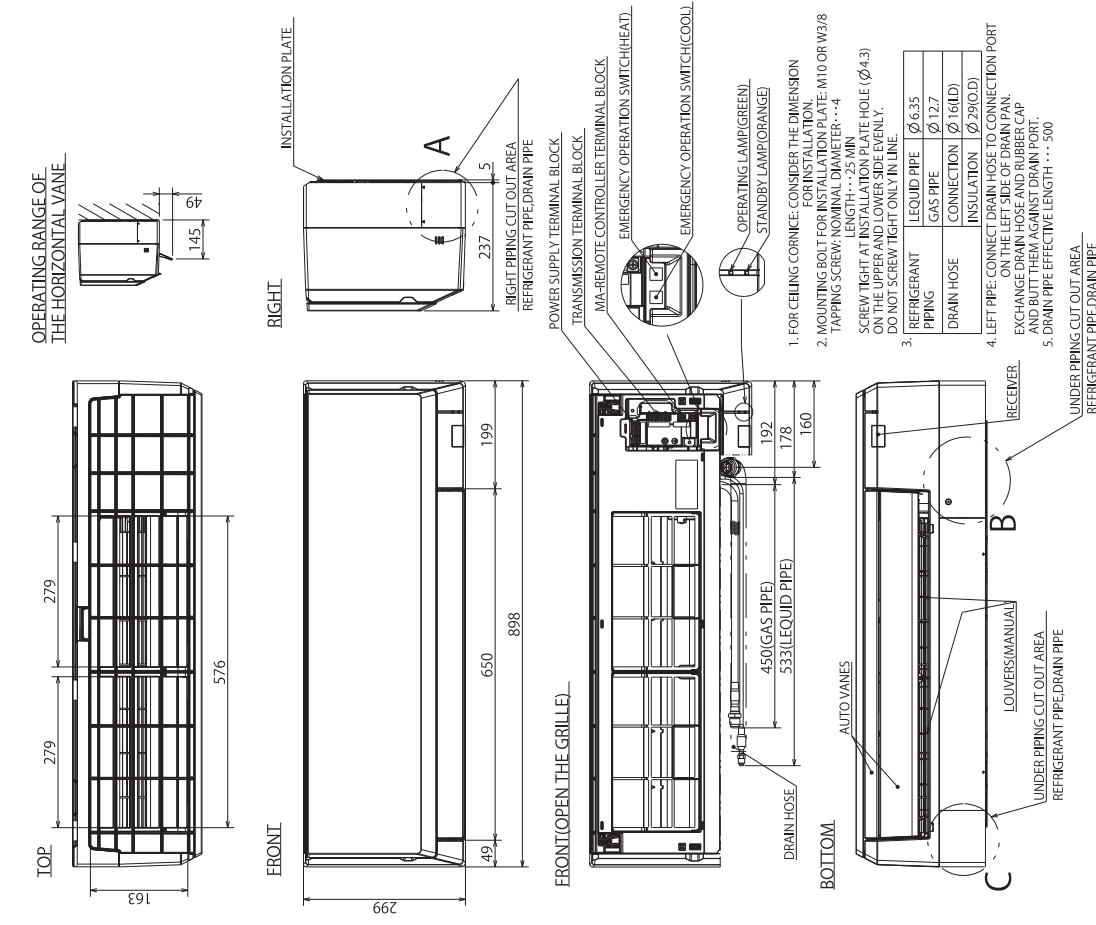

PKFY-MS-VLM-E, VKM-E

PKFY-MS63, 100VKM-E

Unit : mm

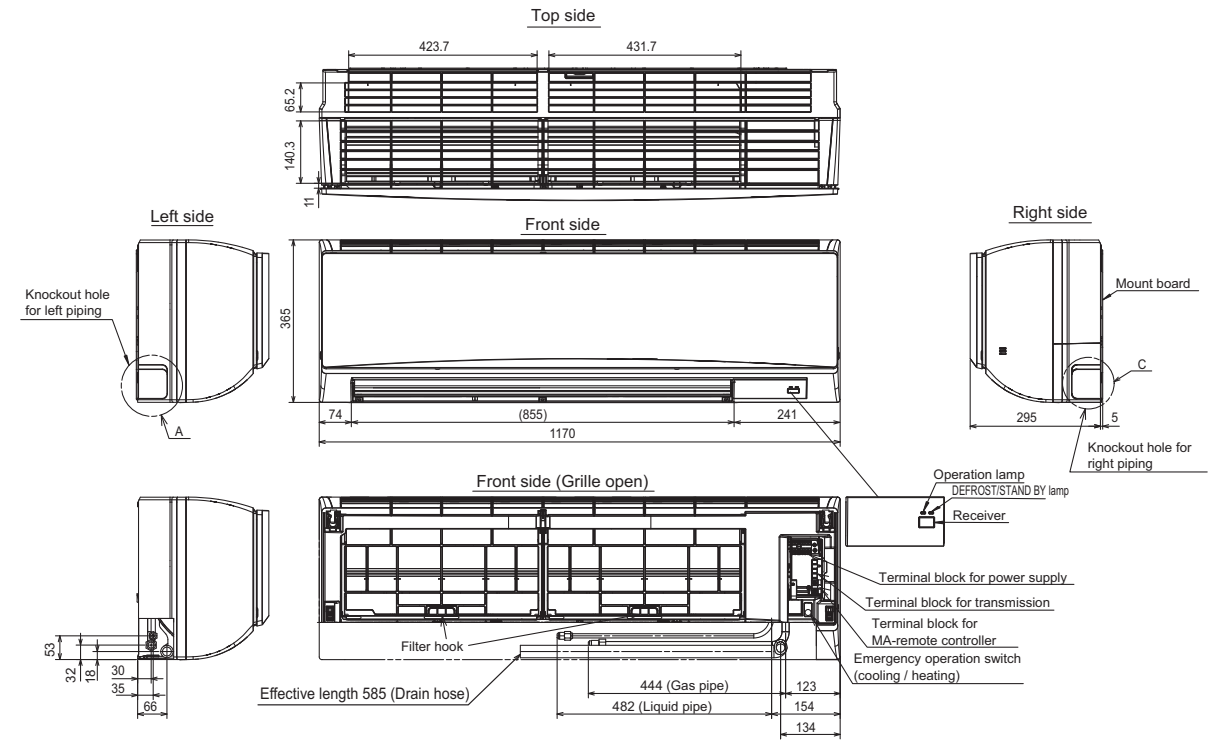

Sleeve (purchased locally)	Through hole
φ75	φ75~φ80

Piping connection department	Size	
	MS63	MS100
① Liquid pipe	Refrigerant pipe : φ9.52 Flared connection : 3/8F	
② Gas pipe	Refrigerant pipe : φ15.88 Flared connection : 5/8F	
③ Drain hose	φ16 O.D	

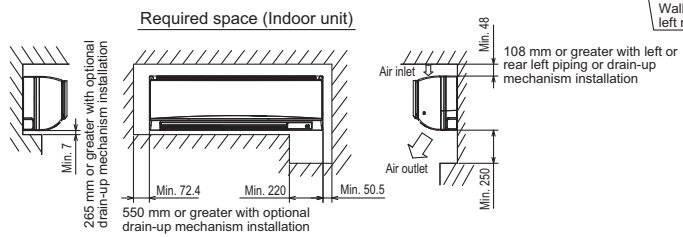
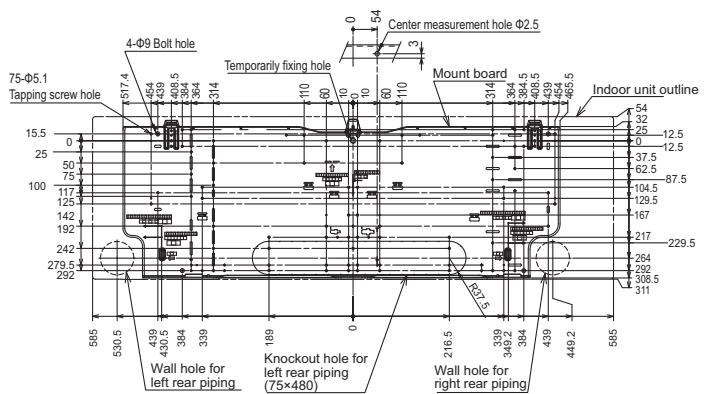
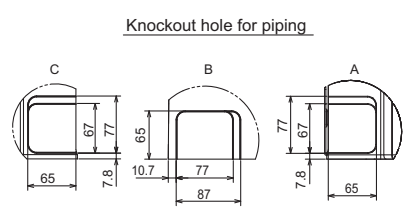
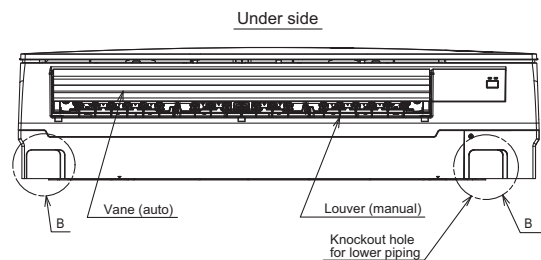

PKFY-MS-VLM-E, VKM-E

PKFY-MS-VLM-E, VKM-E

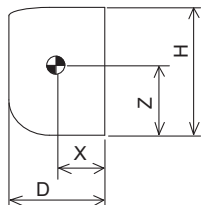
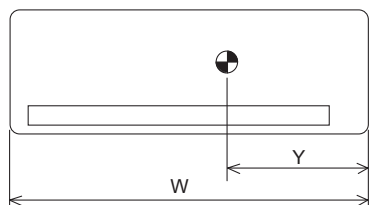

(mm)

Model	W	D	H	X	Y	Z
PKFY-MS10VLM-E	773	237	299	130	340	150
PKFY-MS15VLM-E	773	237	299	130	340	150
PKFY-MS20VLM-E	773	237	299	130	340	150
PKFY-MS25VLM-E	773	237	299	130	340	150
PKFY-MS32VLM-E	773	237	299	130	340	150
PKFY-MS40VLM-E	898	237	299	120	390	150
PKFY-MS50VLM-E	898	237	299	120	390	150
PKFY-MS63VKM-E	1170	295	365	190	460	190
PKFY-MS100VKM-E	1170	295	365	190	460	190