

PFFY-P-VCM-E

1. SPECIFICATIONS 3 - 324

2. EXTERNAL DIMENSIONS 3 - 326

3. CENTER OF GRAVITY 3 - 330

4. ELECTRICAL WIRING DIAGRAMS 3 - 331

5. SOUND LEVELS 3 - 332

 5-1. Sound levels 3 - 332

 5-2. NC curves 3 - 332

6. FAN CHARACTERISTICS CURVES 3 - 335

7. ELECTRICAL CHARACTERISTICS 3 - 338

1. SPECIFICATIONS

Floor standing (Concealed type)

Model		PFFY-P20VCM-E	PFFY-P25VCM-E	PFFY-P32VCM-E	PFFY-P40VCM-E	
Power source		1-phase 220-230-240 V 50/60 Hz	1-phase 220-230-240 V 50/60 Hz	1-phase 220-230-240 V 50/60 Hz	1-phase 220-230-240 V 50/60 Hz	
Cooling capacity (Nominal)	*1 kW	2.2	2.8	3.6	4.5	
	*1 kcal/h	1,900	2,400	3,100	3,900	
	*1 BTU/h	7,500	9,600	12,300	15,400	
	*2 Power input kW	0.022	0.026	0.031	0.038	
	*2 Current input A	0.25	0.30	0.34	0.38	
Heating capacity (Nominal)	*3 kW	2.5	3.2	4.0	5.0	
	*3 kcal/h	2,200	2,800	3,400	4,300	
	*3 BTU/h	8,500	10,900	13,600	17,100	
	*2 Power input kW	0.022	0.026	0.031	0.038	
	*2 Current input A	0.25	0.30	0.34	0.38	
External finish		Galvanized steel plate	Galvanized steel plate	Galvanized steel plate	Galvanized steel plate	
External dimension H x W x D						
		*4 mm 615 (690) x 700 x 200	615 (690) x 700 x 200	615 (690) x 700 x 200	615 (690) x 900 x 200	
		*4 in. 24-1/4 (27-3/16) x 27-9/16 x 7-7/8	24-1/4 (27-3/16) x 27-9/16 x 7-7/8	24-1/4 (27-3/16) x 27-9/16 x 7-7/8	24-1/4 (27-3/16) x 35-7/16 x 7-7/8	
Net weight		kg (lbs) 18 (40)	18 (40)	18.5 (42)	22.5 (51)	
Heat exchanger		Cross fin (Aluminum fin and copper tube)	Cross fin (Aluminum fin and copper tube)	Cross fin (Aluminum fin and copper tube)	Cross fin (Aluminum fin and copper tube)	
FAN		Sirocco fan x 2	Sirocco fan x 2	Sirocco fan x 2	Sirocco fan x 3	
*5	Type x Quantity	Sirocco fan x 2	Sirocco fan x 2	Sirocco fan x 2	Sirocco fan x 3	
	External static press.	Pa	<0> - 10 - <40> - <60>	<0> - 10 - <40> - <60>	<0> - 10 - <40> - <60>	<0> - 10 - <40> - <60>
		mmH ₂ O	<0.0> - 1.0 - <4.1> - <6.1>	<0.0> - 1.0 - <4.1> - <6.1>	<0.0> - 1.0 - <4.1> - <6.1>	<0.0> - 1.0 - <4.1> - <6.1>
	Motor Type	DC motor	DC motor	DC motor	DC motor	
	Motor output	kW 0.096	0.096	0.096	0.096	
	Driving mechanism	Direct-driven by motor	Direct-driven by motor	Direct-driven by motor	Direct-driven by motor	
	Air flow rate	(Low-Mid-High)		(Low-Mid-High)	(Low-Mid-High)	(Low-Mid-High)
		m ³ /min	5.0 - 6.0 - 7.0	5.5 - 6.5 - 8.0	5.5 - 7.0 - 8.5	8.0 - 9.5 - 11.0
		L/s	83 - 100 - 117	92 - 108 - 133	92 - 117 - 142	133 - 158 - 183
		cfm	177 - 212 - 247	194 - 230 - 282	194 - 247 - 300	282 - 335 - 388
Sound pressure level (measured in anechoic room)		(Low-Mid-High)	(Low-Mid-High)	(Low-Mid-High)	(Low-Mid-High)	
		*2 dB <A> 21-23-26	22-25-29	23-26-30	25-27-30	
Insulation material		Polystyrene foam, Polyethylene foam, Urethane foam	Polystyrene foam, Polyethylene foam, Urethane foam	Polystyrene foam, Polyethylene foam, Urethane foam	Polystyrene foam, Polyethylene foam, Urethane foam	
Air filter		PP honeycomb fabric.	PP honeycomb fabric.	PP honeycomb fabric.	PP honeycomb fabric.	
Protection device		Fuse	Fuse	Fuse	Fuse	
Refrigerant control device		LEV	LEV	LEV	LEV	
Connectable outdoor unit		R410A CITY MULTI	R410A CITY MULTI	R410A CITY MULTI	R410A CITY MULTI	
Refrigerant piping diameter	Liquid (R410A)	mm (in.) 6.35 (1/4)Brazed	6.35 (1/4)Brazed	6.35 (1/4)Brazed	6.35 (1/4)Brazed	
	Gas (R410A)	mm (in.) 12.7 (1/2)Brazed	12.7 (1/2)Brazed	12.7 (1/2)Brazed	12.7 (1/2)Brazed	
Field drain pipe size		mm (in.) O.D.32 (1-1/4)	O.D.32 (1-1/4)	O.D.32 (1-1/4)	O.D.32 (1-1/4)	
Drawing	External	KL94T467, KL94R934	KL94T467, KL94R934	KL94T467, KL94R934	KL94T467, KL94R934	
	Wiring	KL94R950	KL94R950	KL94R950	KL94R950	
	Refrigerant cycle	-	-	-	-	
Standard attachment	Document	Installation Manual, Instruction Book	Installation Manual, Instruction Book	Installation Manual, Instruction Book	Installation Manual, Instruction Book	
	Accessory	Washer, Drain hose, Tie band, Leg, Screw	Washer, Drain hose, Tie band, Leg, Screw	Washer, Drain hose, Tie band, Leg, Screw	Washer, Drain hose, Tie band, Leg, Screw	
Optional parts						
Remarks		* Details on foundation work, duct work, insulation work, electrical wiring, power source switch, and other items shall be referred to the Installation Manual. * Due to continuing improvement, above specifications may be subject to change without notice.				

Notes:	Unit converter
1.Nominal cooling conditions Indoor: 27°C D.B./19°C W.B. (81°F D.B./66°F W.B.), Outdoor: 35°C D.B. (95°F D.B.) Pipe length: 7.5 m (24-9/16 ft.), Level difference: 0 m (0 ft.)	kcal =kW x 860 BTU/h =kW x 3,412
2.The values are measured at the factory setting of external static pressure.	cfm =m ³ /min x 35.31
3.Nominal heating conditions Indoor: 20°C D.B. (68°F D.B.), Outdoor: 7°C D.B./6°C W.B. (45°F D.B./43°F W.B.) Pipe length: 7.5 m (24-9/16 ft.), Level difference: 0 m (0 ft.)	lbs =kg/0.4536
4.The values in () show the height of unit with leg.	
5.The factory setting of external static pressure is shown without < >. Refer to "Fan characteristics curves", according to the external static pressure, in DATA BOOK for the usable range of air flow rate.	
*This unit cannot be connected to PUMY-Series except PUMY-P112, 125, 140V(Y)KM(E)4.	*Above specification data is subject to rounding variation.

PFFY-P-VCM-E

1. SPECIFICATIONS

Floor standing (Concealed type)

Model		PPFY-P50VCM-E	PPFY-P63VCM-E		
Power source		1-phase 220-230-240 V 50/60 Hz	1-phase 220-230-240 V 50/60 Hz		
Cooling capacity (Nominal)	*1	kW	5.6	7.1	
	*1	kcal/h	4,800	6,100	
	*1	BTU/h	19,100	24,200	
	*2	Power input	kW	0.052	0.058
	*2	Current input	A	0.50	0.49
Heating capacity (Nominal)	*3	kW	6.3	8.0	
	*3	kcal/h	5,400	6,900	
	*3	BTU/h	21,500	27,300	
	*2	Power input	kW	0.052	0.058
	*2	Current input	A	0.50	0.49
External finish		Galvanized steel plate	Galvanized steel plate		
External dimension H x W x D		*4 mm	615 (690) x 900 x 200	615 (690) x 1,100 x 200	
		*4 in.	24-1/4 (27-3/16) x 35-7/16 x 7-7/8	24-1/4 (27-3/16) x 43-5/16 x 7-7/8	
Net weight		kg (lbs)	22.5 (51)	25.5 (58)	
Heat exchanger			Cross fin (Aluminum fin and copper tube)	Cross fin (Aluminum fin and copper tube)	
FAN	Type x Quantity		Sirocco fan x 3	Sirocco fan x 4	
	*5 External static press.	Pa	<0> - 10 - <40> - <60>	<0> - 10 - <40> - <60>	
		mmH ₂ O	<0.0> - 1.0 - <4.1> - <6.1>	<0.0> - 1.0 - <4.1> - <6.1>	
	Motor Type		DC motor	DC motor	
	Motor output		kW	0.096	0.096
	Driving mechanism		Direct-driven by motor	Direct-driven by motor	
	Air flow rate		(Low-Mid-High)	(Low-Mid-High)	
			m ³ /min	10.0 - 11.5 - 13.5	12.0 - 14.0 - 16.5
		L/s	167 - 192 - 225	200 - 233 - 275	
		cfm	353 - 406 - 477	424 - 494 - 583	
Sound pressure level (measured in anechoic room)			(Low-Mid-High)	(Low-Mid-High)	
		*2 dB <A>	28-31-34	28-32-35	
Insulation material			Polystyrene foam, Polyethylene foam, Urethane foam	Polystyrene foam, Polyethylene foam, Urethane foam	
Air filter			PP honeycomb fabric.	PP honeycomb fabric.	
Protection device			Fuse	Fuse	
Refrigerant control device			LEV	LEV	
Connectable outdoor unit			R410A CITY MULTI	R410A CITY MULTI	
Refrigerant piping diameter	Liquid (R410A)	mm (in.)	6.35 (1/4)Braze	9.52 (3/8)Braze	
	Gas (R410A)	mm (in.)	12.7 (1/2)Braze	15.88 (5/8)Braze	
Field drain pipe size		mm (in.)	O.D.32 (1-1/4)	O.D.32 (1-1/4)	
Drawing	External		KL94T467, KL94R934	KL94T467, KL94R934	
	Wiring		KL94R950	KL94R950	
	Refrigerant cycle		-	-	
Standard attachment	Document		Installation Manual, Instruction Book	Installation Manual, Instruction Book	
	Accessory		Washer, Drain hose, Tie band, Leg, Screw	Washer, Drain hose, Tie band, Leg, Screw	
Optional parts					
Remarks		* Details on foundation work, duct work, insulation work, electrical wiring, power source switch, and other items shall be referred to the Installation Manual. * Due to continuing improvement, above specifications may be subject to change without notice.			

Notes:	Unit converter
1. Nominal cooling conditions Indoor: 27°C D.B./19°C W.B. (81°F D.B./66°F W.B.), Outdoor: 35°C D.B. (95°F D.B.) Pipe length: 7.5 m (24-9/16 ft.), Level difference: 0 m (0 ft.) 2. The values are measured at the factory setting of external static pressure.	kcal =kW x 860 BTU/h =kW x 3,412 cfm =m ³ /min x 35.31 lbs =kg/0.4536
3. Nominal heating conditions Indoor: 20°C D.B. (68°F D.B.), Outdoor: 7°C D.B./6°C W.B. (45°F D.B./43°F W.B.) Pipe length: 7.5 m (24-9/16 ft.), Level difference: 0 m (0 ft.) 4. The values in () show the height of unit with leg. 5. The factory setting of external static pressure is shown without < > . Refer to "Fan characteristics curves", according to the external static pressure, in DATA BOOK for the usable range of air flow rate. * This unit cannot be connected to PUMY-Series except PUMY-P112, 125, 140V(KM)(E)4.	*Above specification data is subject to rounding variation.

PPFY-P-VCM-E

PFFY-P20, 25, 32, 40, 50, 63VCM-E Bottom suction · wall mounting

Unit: mm

- Note 1. Use an M10 screw for the wall and floor mounting bolt (field supply).
 2. This drawing is for PFFY-P63VCM-E model, which have 4 fans.
 PFFY-P40-50VCM-E models have 3 fan.
 PFFY-P20-25-32VCM-E models have 2 fan.

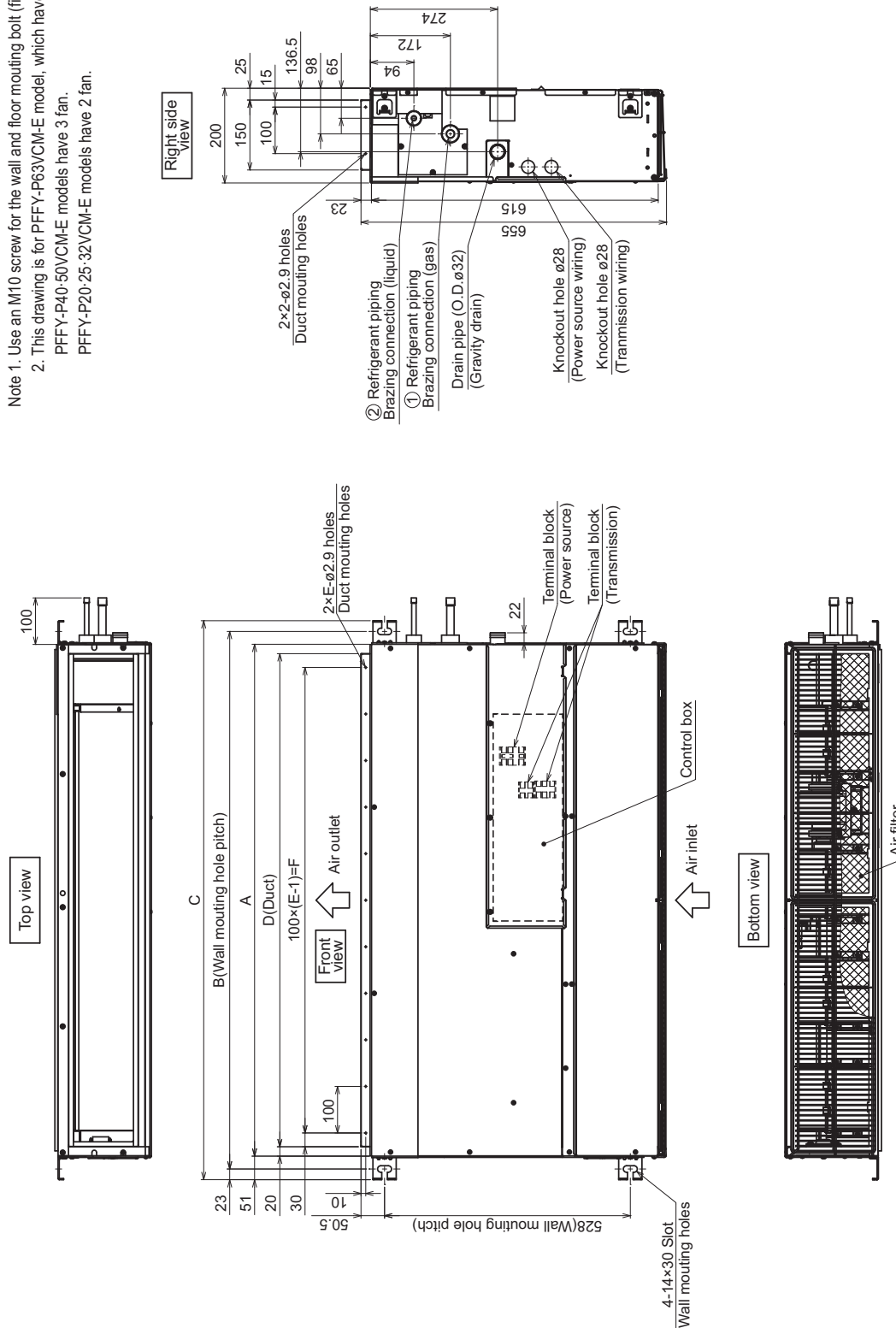

Model	A	B	C	D	E	F	① Gas pipe	② Liquid pipe
PFFY-P20-25-32VCM-E	700	756	802	660	7	600	φ12.7	φ6.35
PFFY-P40-50VCM-E	900	956	1002	860	9	800	φ12.7	φ6.35
PFFY-P63VCM-E	1100	1156	1202	1060	11	1000	φ15.88	φ9.52

PFFY-P-VCME-E

PFFY-P20, 25, 32, 40, 50, 63VCM-E Bottom suction · wall mounting

Unit: mm

[Maintenance access space]
 Secure enough access space to allow for the maintenance, inspection,
 and replacement of the motor, fan, heat exchanger, drain pan and control box.

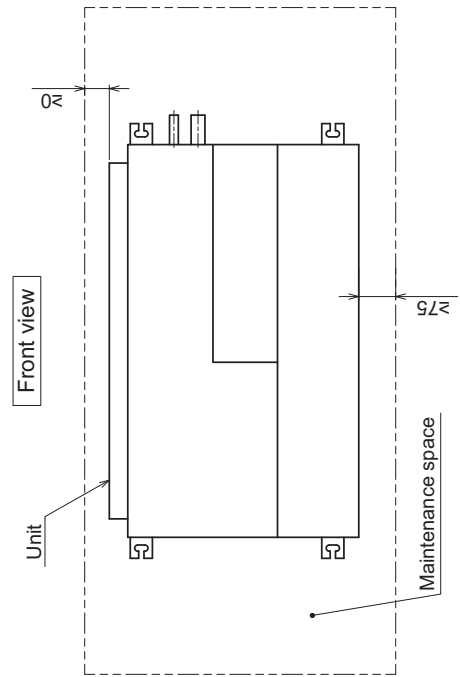
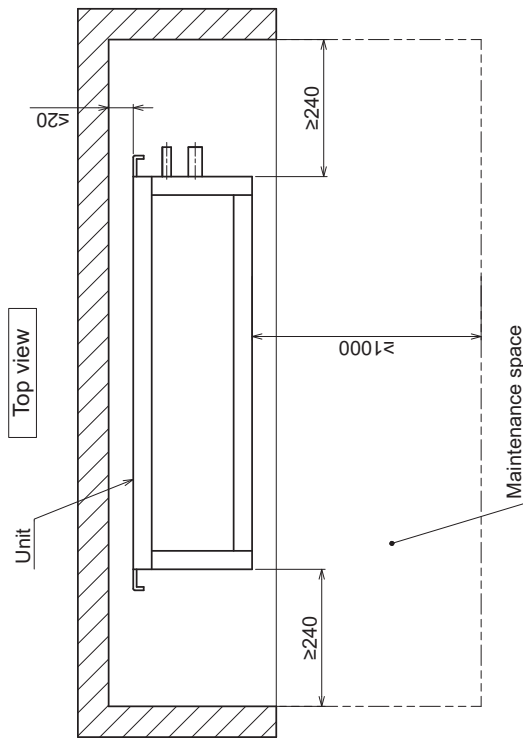

PFFY-P20, 25, 32, 40, 50, 63VCM-E Bottom suction · floor mounting

Unit: mm

- Note 1. Use an M10 screw for the wall and floor mounting bolt (field supply).
 2. This drawing is for PFFY-P63VCM-E model, which have 4 fans.
 PFFY-P40-50VCM-E models have 3 fan.
 PFFY-P20-25-32VCM-E models have 2 fan.

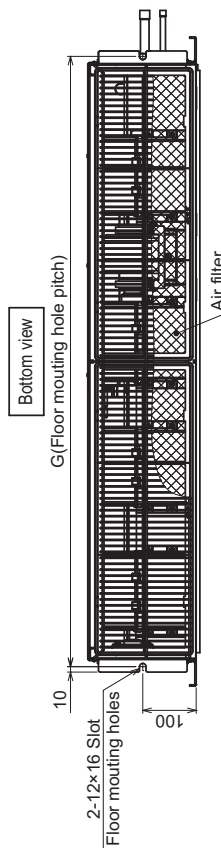
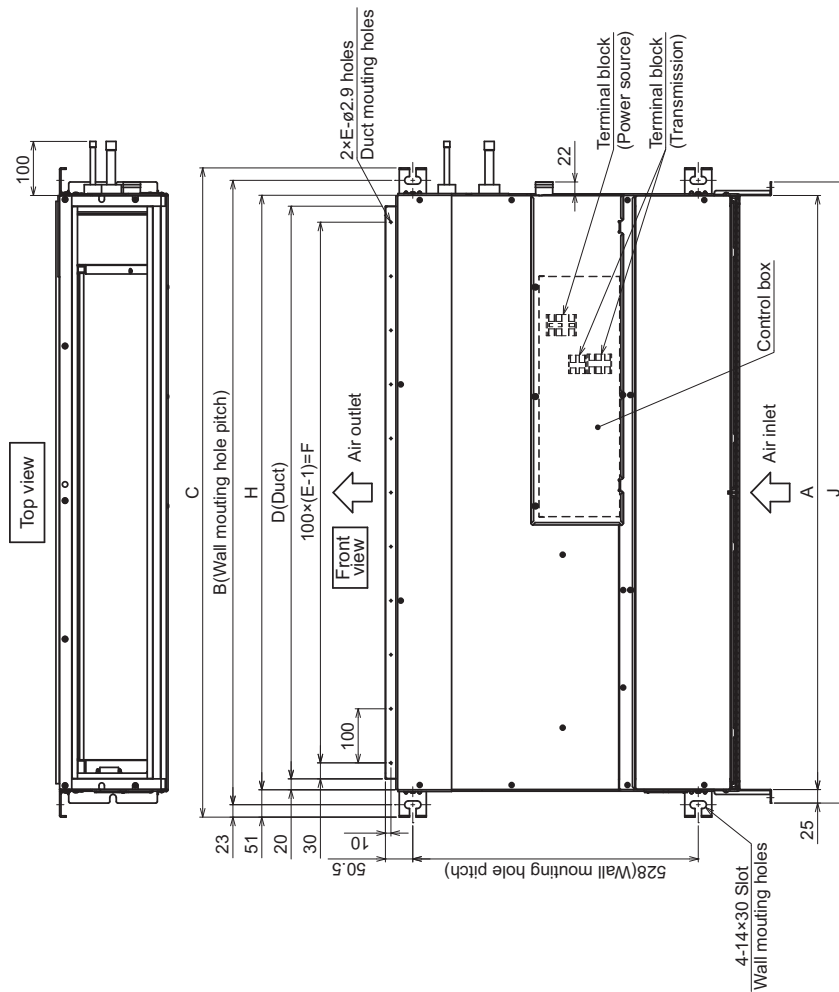
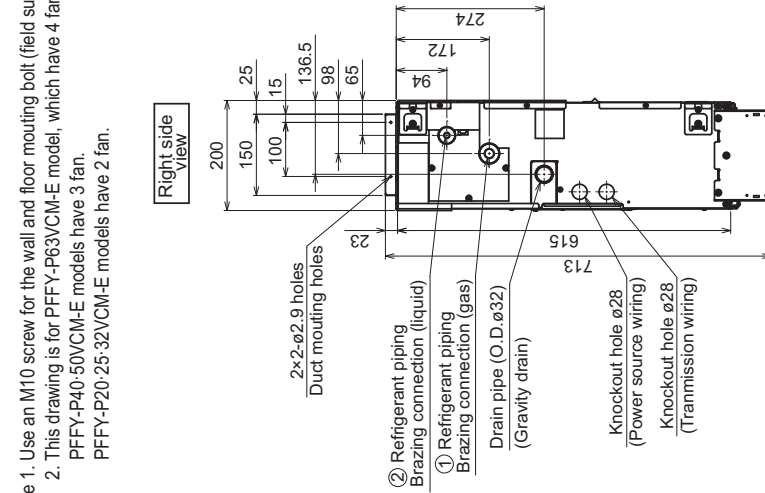

Model	A	B	C	D	E	F	G	H	J	① Gas pipe	② Liquid pipe
PFFY-P20-25-32VCM-E	700	756	802	660	7	600	730	700	750	ø12.7	ø6.35
PFFY-P40-50VCM-E	900	956	1002	860	9	800	930	900	950		
PFFY-P63VCM-E	1100	1156	1202	1060	11	1000	1130	1100	1150	ø15.88	ø9.52

PFFY-P-VCME

PFFY-P20, 25, 32, 40, 50, 63VCM-E Bottom suction · floor mounting

Unit: mm

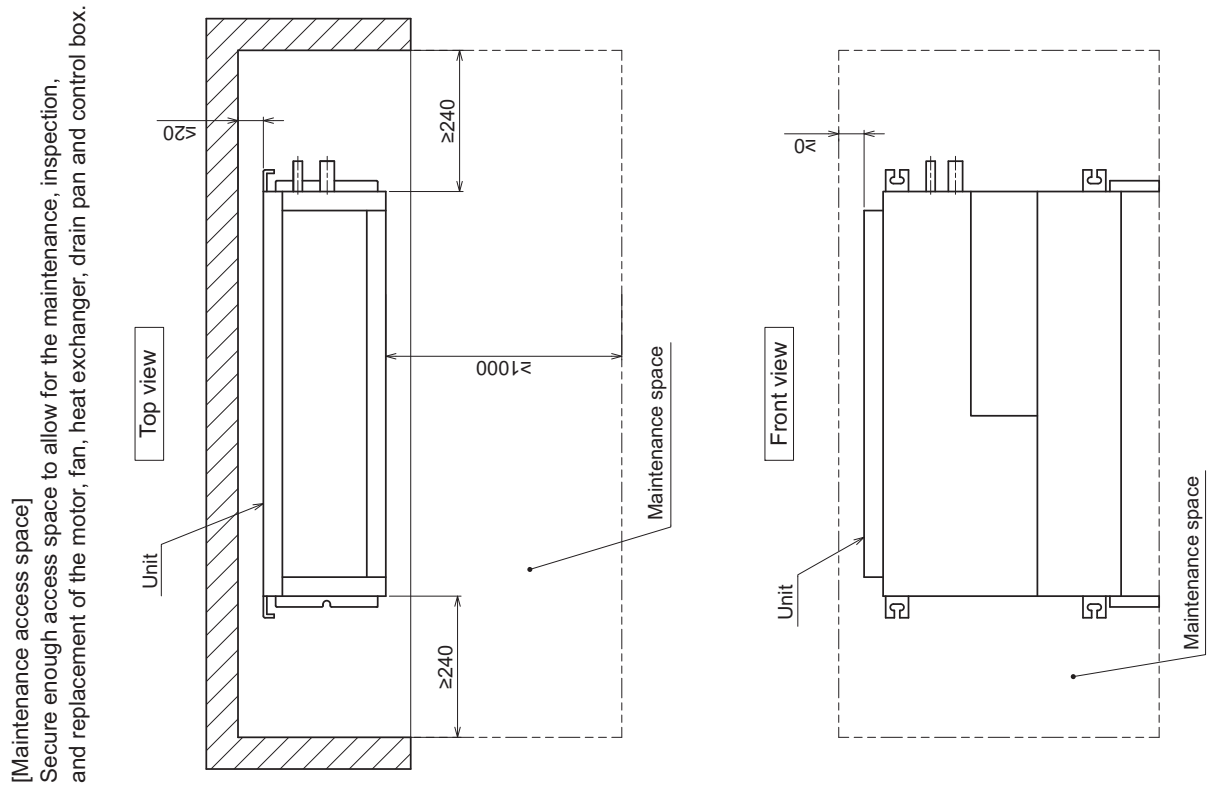

PFFY-P-VCM-E

PFFY-P20, 25, 32, 40, 50, 63VCM-E

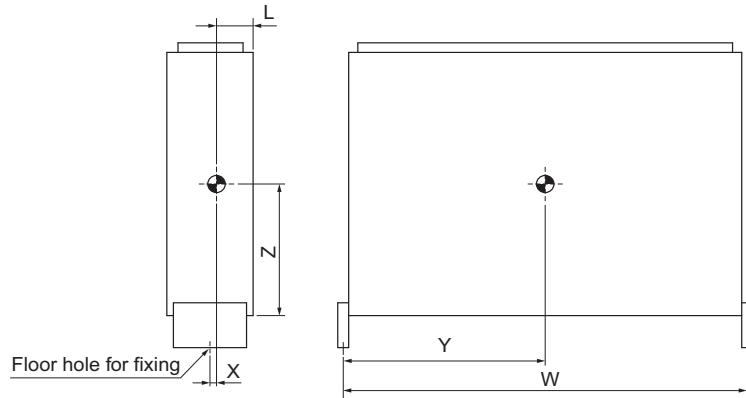

(mm) [in]

Model name	W	L	X	Y	Z
PFFY-P20VCM-E	730 [28-3/4]	95 [3-3/4]	5 [1/4]	365 [14-3/8]	290 [11-7/16]
PFFY-P25VCM-E	730 [28-3/4]	95 [3-3/4]	5 [1/4]	365 [14-3/8]	290 [11-7/16]
PFFY-P32VCM-E	730 [28-3/4]	95 [3-3/4]	5 [1/4]	365 [14-3/8]	290 [11-7/16]
PFFY-P40VCM-E	930 [36-5/8]	95 [3-3/4]	5 [1/4]	495 [19-1/2]	300 [11-13/16]
PFFY-P50VCM-E	930 [36-5/8]	95 [3-3/4]	5 [1/4]	495 [19-1/2]	300 [11-13/16]
PFFY-P63VCM-E	1130 [44-1/2]	95 [3-3/4]	5 [1/4]	615 [24-1/4]	320 [12-5/8]

PFFY-P-VCM-E

PFFY-P20, 25, 32, 40, 50, 63VCM-E

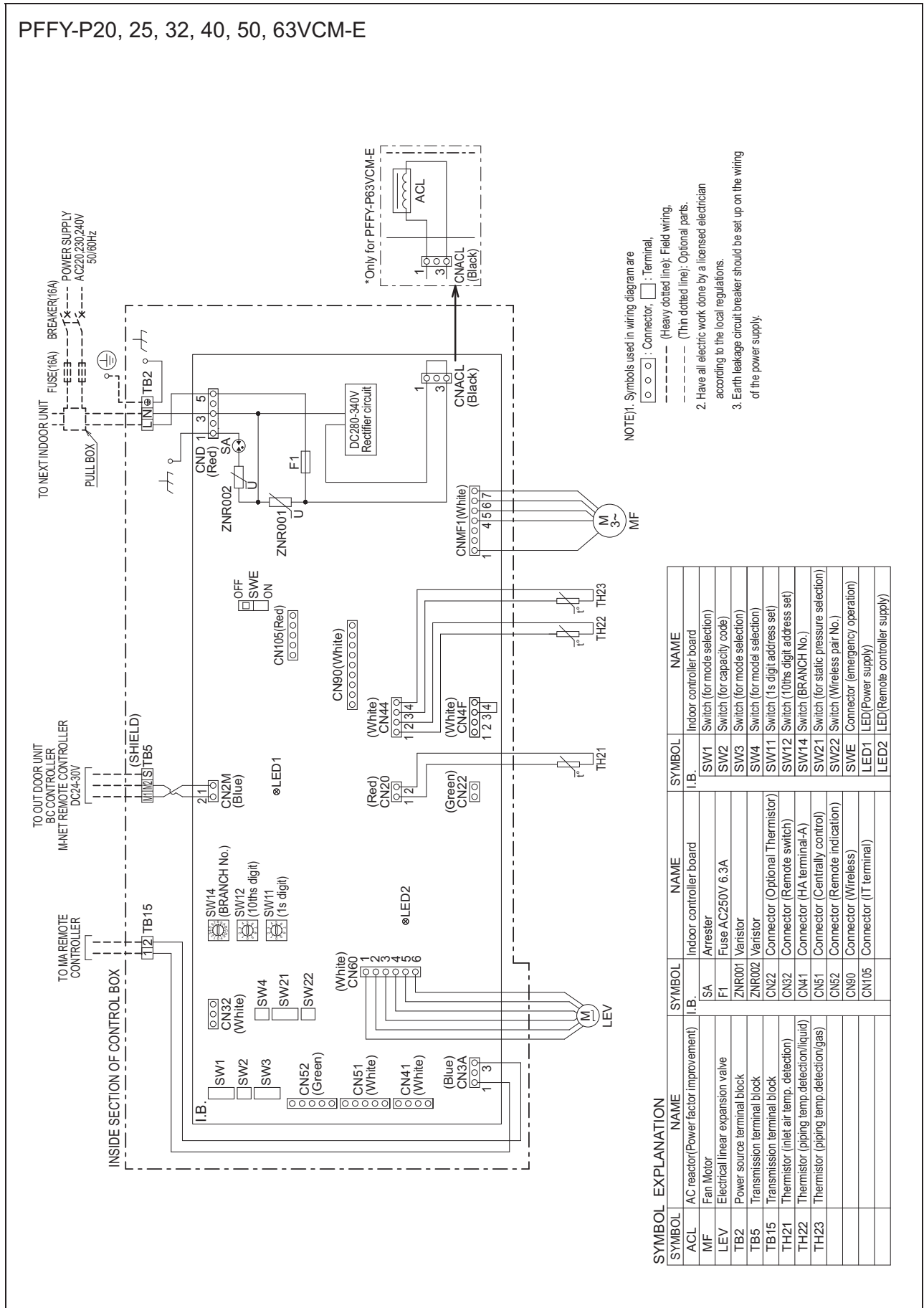

NOTE1: Symbols used in wiring diagram are
 ○ ○ ○ ○ : Connector, □ : Terminal,
 --- (Heavy dotted line): Field wiring,
 --- (Thin dotted line): Optional parts.
 2. Have all electric work done by a licensed electrician according to the local regulations.
 3. Earth leakage circuit breaker should be set up on the wiring of the power supply.

SYMBOL	NAME	SYMBOL	NAME	SYMBOL	NAME
ACL	AC reactor(Power factor improvement)	I. B.	Indoor controller board	SW1	Indoor controller board Switch (for mode selection)
MF	Fan Motor	SA	Arrester	SW2	Switch (for capacity code)
LEV	Electrical linear expansion valve	F1	Fuse AC250V 6.3A	SW3	Switch (for mode selection)
TB2	Power source terminal block	ZNR001	Varistor	SW4	Switch (for mode selection)
TB5	Transmission terminal block	ZNR002	Varistor	SW11	Switch (1s digit address set)
TB15	Transmission terminal block	CN22	Connector (Optional Thermistor)	SW12	Switch (10ths digit address set)
TH21	Thermistor (inlet air temp. detection)	CN32	Connector (Remote switch)	SW14	Switch (BRANCH No.)
TH22	Thermistor (piping temp.detection/liquid)	CN41	Connector (HA terminal-A)	SW21	Switch (for static pressure selection)
TH23	Thermistor (piping temp.detection/gas)	CN51	Connector (Centrally control)	SW22	Switch (Wireless pair No.)
		CN52	Connector (Remote indication)	SWE	Connector (emergency operation)
		CN80	Connector (Wireless)	LED1	LED(Power supply)
		CN105	Connector (1T terminal)	LED2	LED(Remote controller supply)

PFFY-P-VCM-E

5-1. Sound levels

PFFY-P-VCM-E

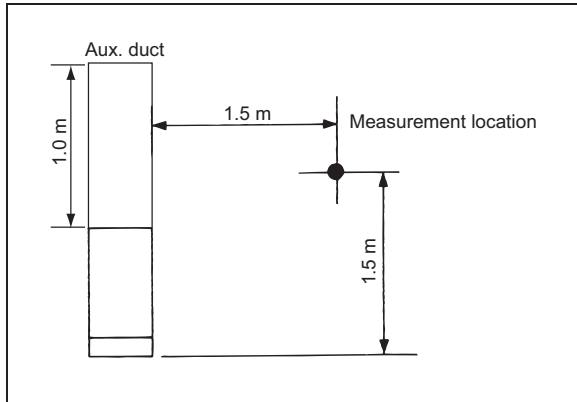

Sound level at anechoic room: Low-Middle-High

	Sound level dB (A)			
	0Pa	10Pa	40Pa	60Pa
PFFY-P20VCM-E	22-26-30	21-23-26	22-25-29	24-28-32
PFFY-P25VCM-E	24-28-33	22-25-29	23-27-32	25-28-33
PFFY-P32VCM-E	25-30-35	23-26-30	24-29-33	26-31-35
PFFY-P40VCM-E	26-30-33	25-27-30	27-30-34	28-32-35
PFFY-P50VCM-E	31-34-38	28-31-34	30-33-36	31-34-38
PFFY-P63VCM-E	31-35-39	28-32-35	30-34-38	32-35-39

* The value for the sound pressure level 0 Pa is the value when the duct is not attached.

* Measured in anechoic room

5-2. NC curves

PFFY-P20VCM-E

External Static Pressure: 0Pa [0.00in.WG]
Power Source: 220-240V

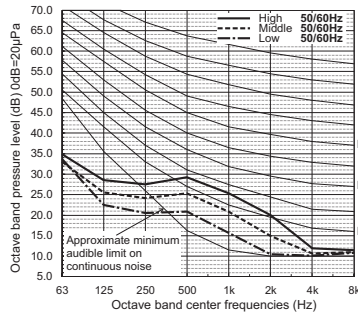

PFFY-P20VCM-E

External Static Pressure: 10Pa [0.04in.WG]
Power Source: 220-240V

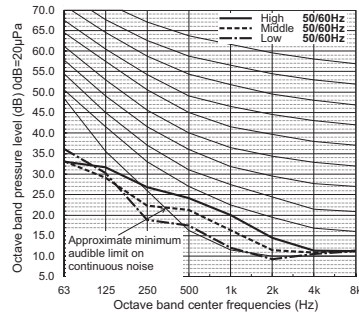

PFFY-P20VCM-E

External Static Pressure: 40Pa [0.16in.WG]
Power Source: 220-240V

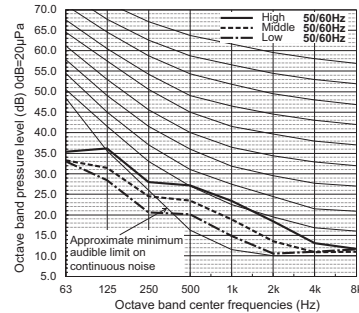

PFFY-P20VCM-E

External Static Pressure: 60Pa [0.24in.WG]
Power Source: 220-240V

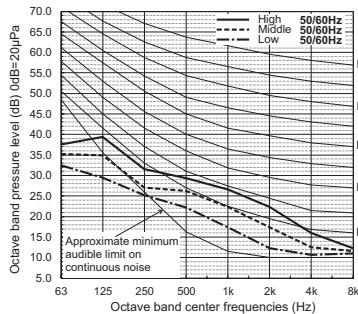

PFFY-P25VCM-E

External Static Pressure: 0Pa [0.00in.WG]
Power Source: 220-240V

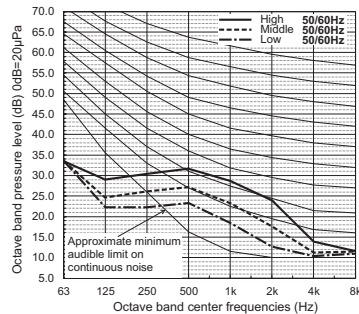

PFFY-P25VCM-E

External Static Pressure: 10Pa [0.04in.WG]
Power Source: 220-240V

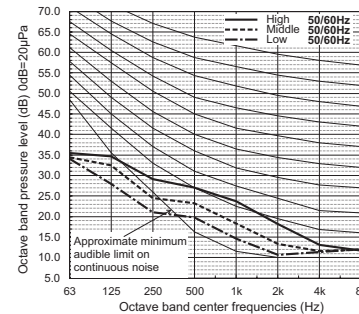

PFFY-P25VCM-E

External Static Pressure: 40Pa [0.16in.WG]
Power Source: 220-240V

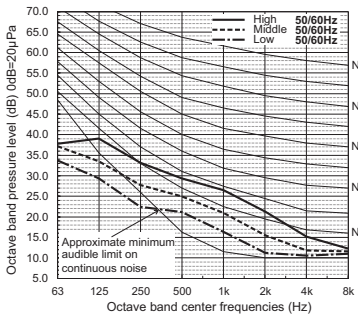

PFFY-P25VCM-E

External Static Pressure: 60Pa [0.24in.WG]
Power Source: 220-240V

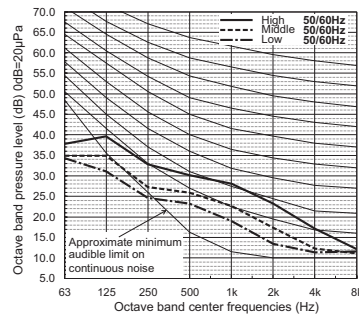

PFFY-P32VCM-E

External Static Pressure: 0Pa [0.00in.WG]
Power Source: 220-240V

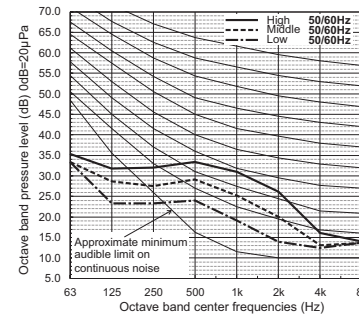

PFFY-P-VCM-E

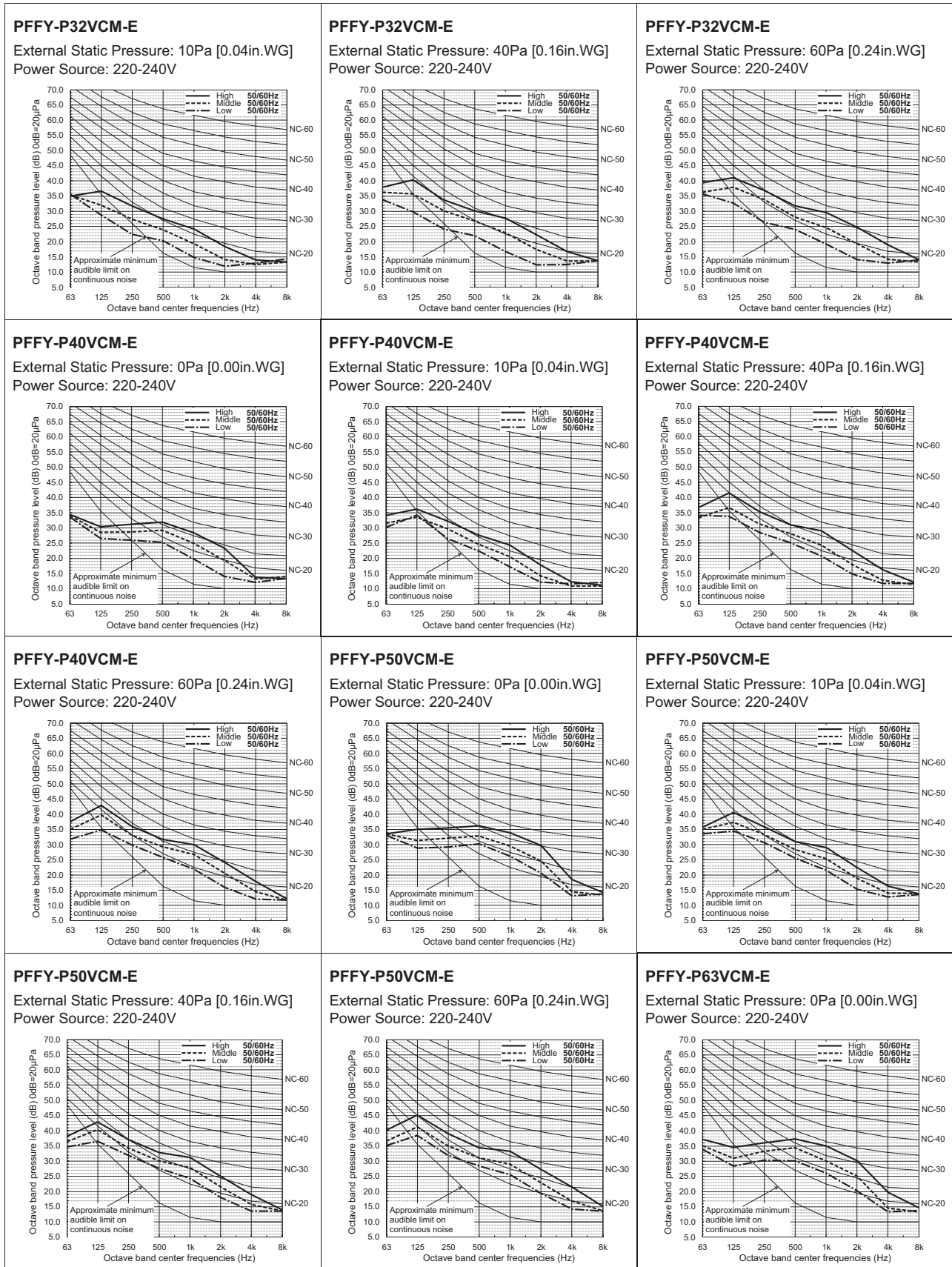

PFFY-P-VC-M-E

PFFY-P63VCM-E

External Static Pressure: 10Pa [0.04in.WG]
Power Source: 220-240V

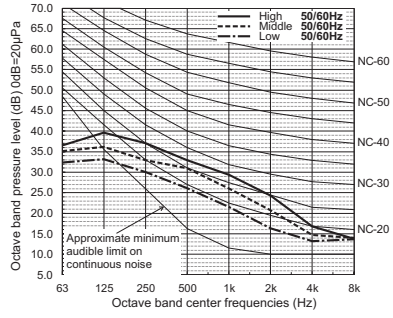

PFFY-P63VCM-E

External Static Pressure: 40Pa [0.16in.WG]
Power Source: 220-240V

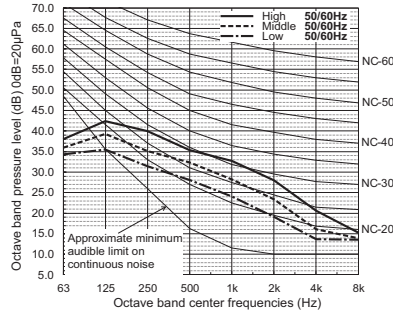

PFFY-P63VCM-E

External Static Pressure: 60Pa [0.24in.WG]
Power Source: 220-240V

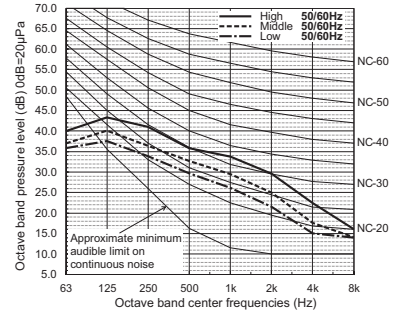

PFFY-P-VCM-E

PFFY-P20VCM-E

External static pressure : 10Pa
Power source : 220-240V

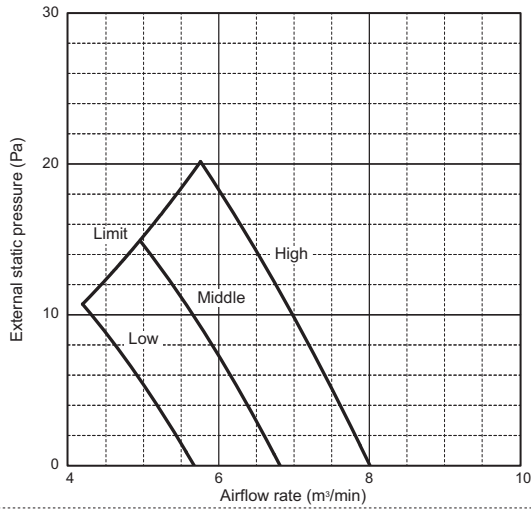

PFFY-P20VCM-E

External static pressure : 40Pa
Power source : 220-240V

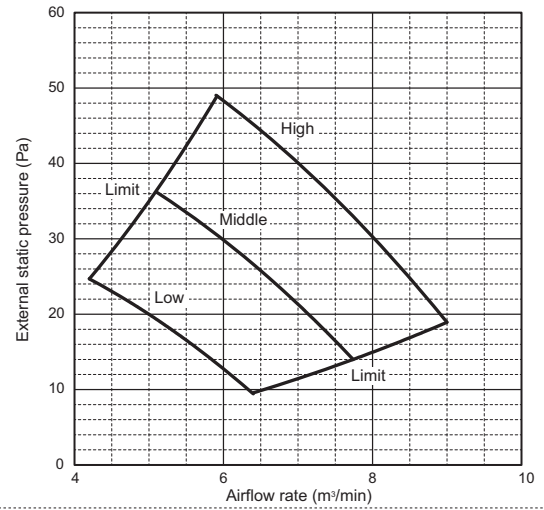

PFFY-P20VCM-E

External static pressure : 60Pa
Power source : 220-240V

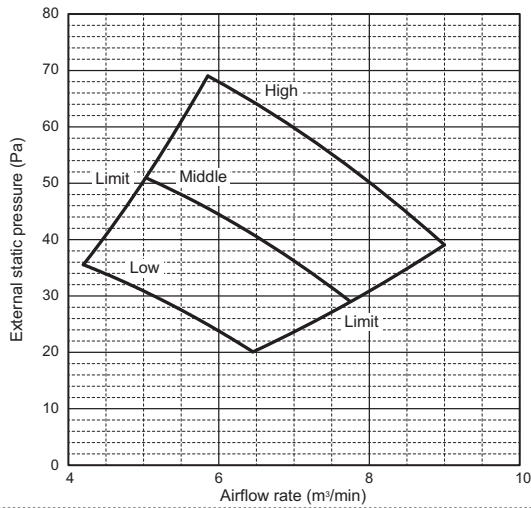

PFFY-P25VCM-E

External static pressure : 10Pa
Power source : 220-240V

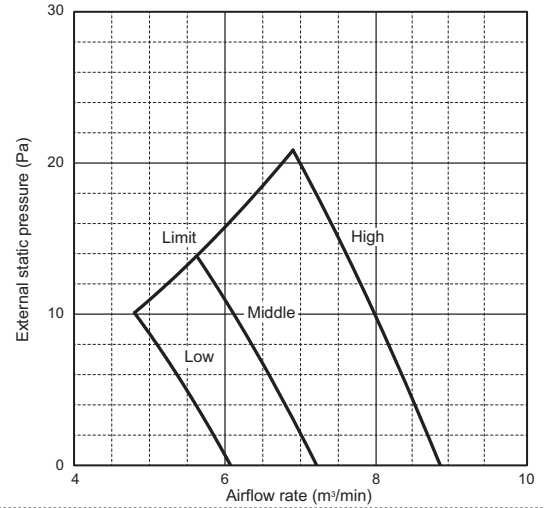

PFFY-P25VCM-E

External static pressure : 40 Pa
Power source : 220-240V

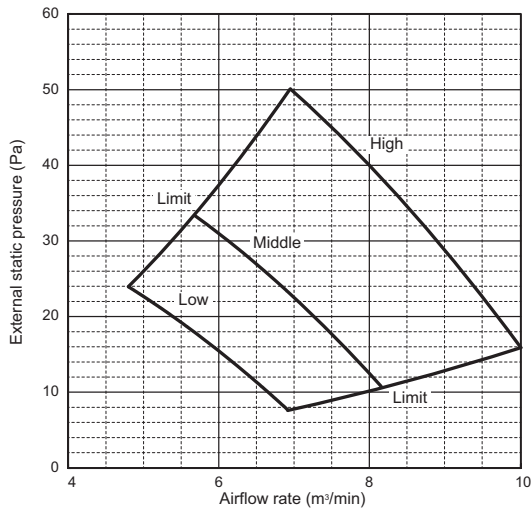

PFFY-P25VCM-E

External static pressure : 60Pa
Power source : 220-240V

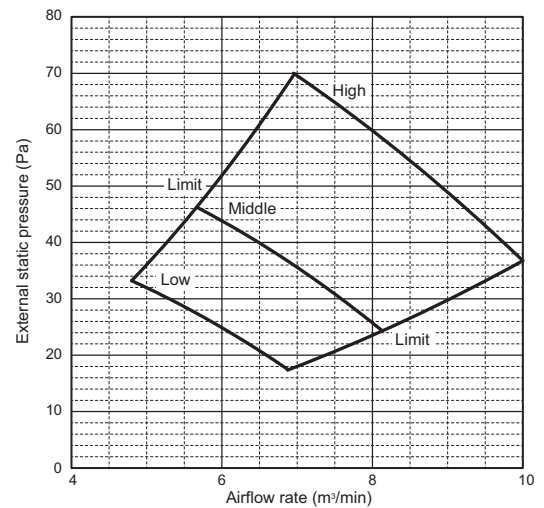

PFFY-P-VCM-E

PFFY-P32VCM-E

External static pressure : 10Pa
Power source : 220-240V

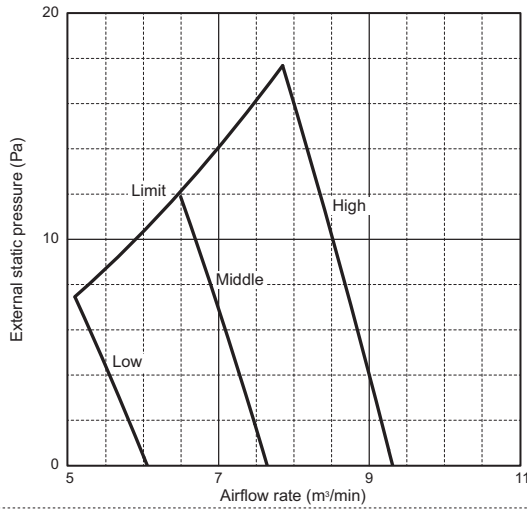

PFFY-P32VCM-E

External static pressure : 40Pa
Power source : 220-240V

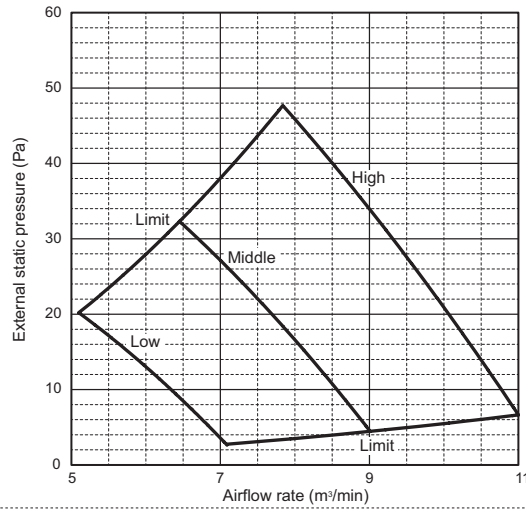

PFFY-P32VCM-E

External static pressure : 60Pa
Power source : 220-240V

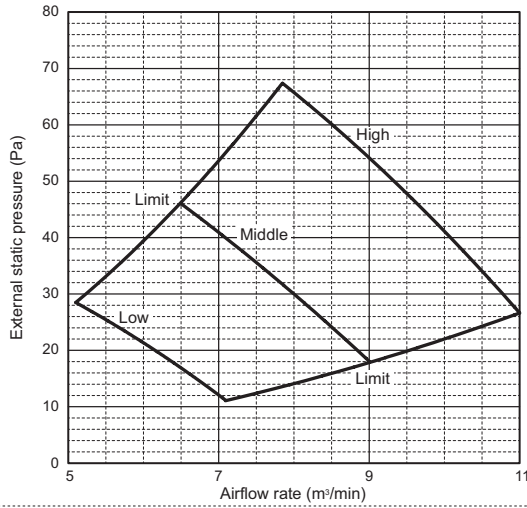

PFFY-P40VCM-E

External static pressure : 10Pa
Power source : 220-240V

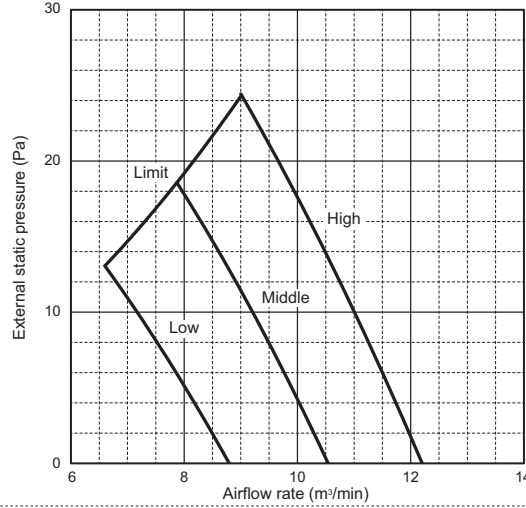

PFFY-P40VCM-E

External static pressure : 40 Pa
Power source : 220-240V

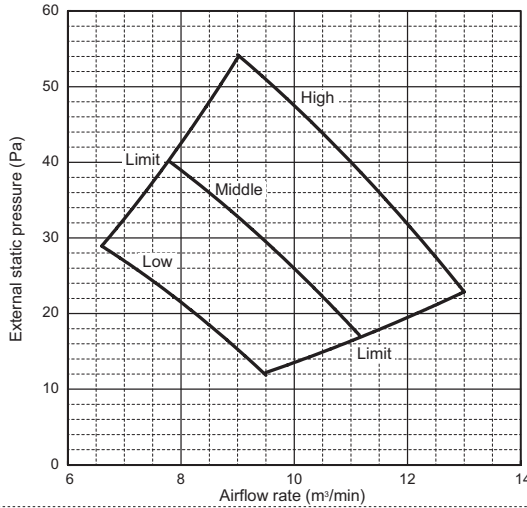

PFFY-P40VCM-E

External static pressure : 60Pa
Power source : 220-240V

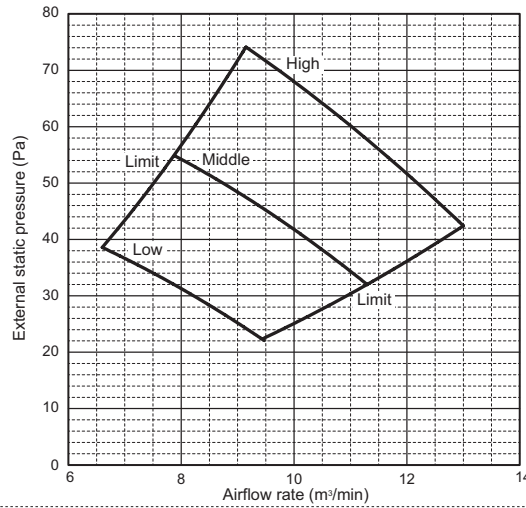

PFFY-P-VCM-E

PFFY-P50VCM-E

External static pressure : 10Pa
Power source : 220-240V

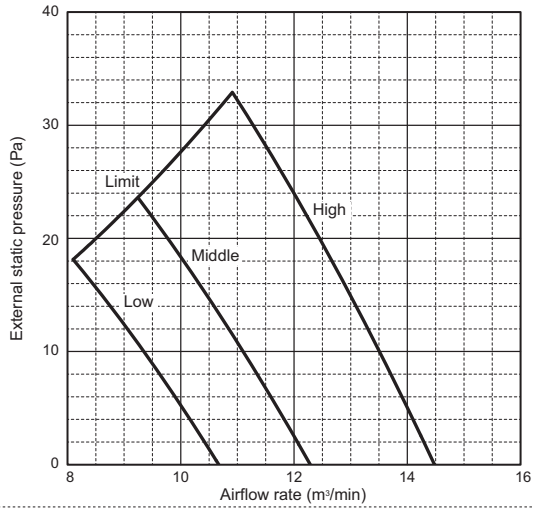

PFFY-P50VCM-E

External static pressure : 40Pa
Power source : 220-240V

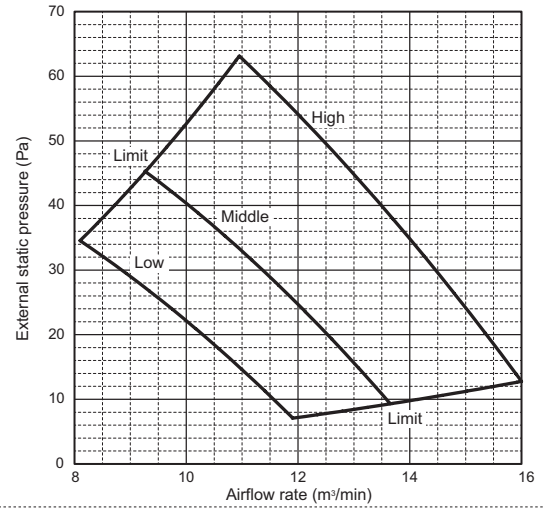

PFFY-P50VCM-E

External static pressure : 60Pa
Power source : 220-240V

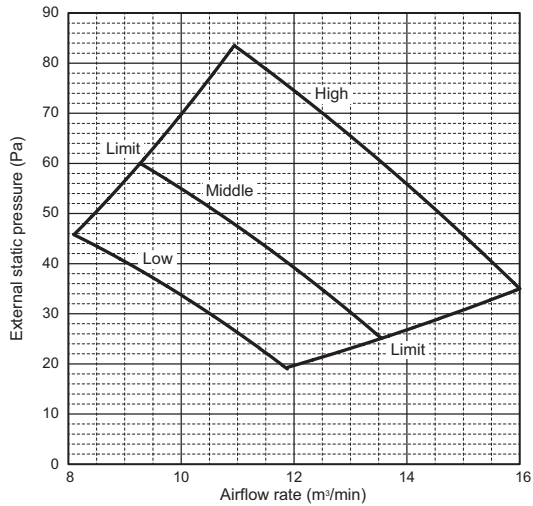

PFFY-P63VCM-E

External static pressure : 10Pa
Power source : 220-240V

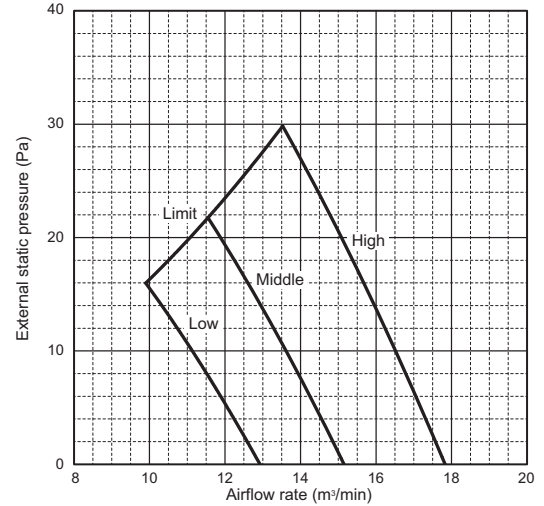

PFFY-P63VCM-E

External static pressure : 40 Pa
Power source : 220-240V

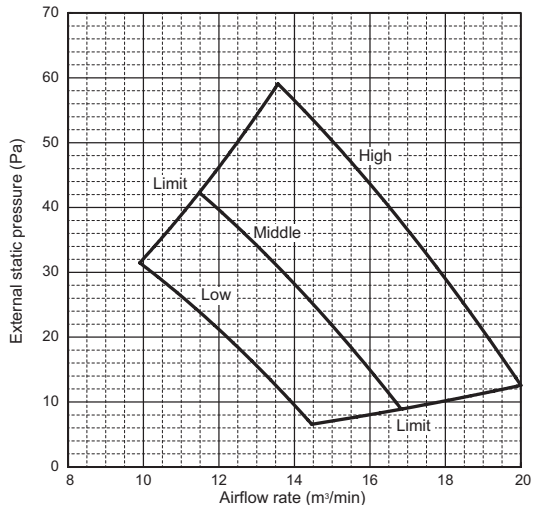

PFFY-P63VCM-E

External static pressure : 60Pa
Power source : 220-240V

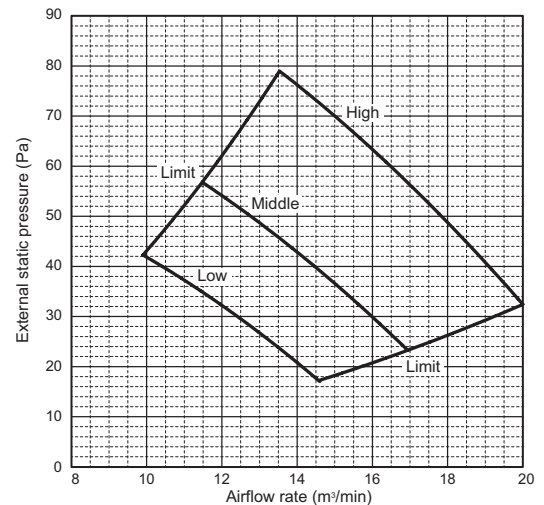

PFFY-P-VCM-E

7. ELECTRICAL CHARACTERISTICS

Floor standing (Concealed type)

Symbols: MCA (Max.Circuit Amps =1.25xFLA), FLA (Full Load Amps)
IFM (Indoor Fan Motor), Output (Fan motor rated output)

PFFY-P-VCM-E	Power supply			IFM	
	Volts/Hz	Range +/-10%	MCA (A)	Output (kW)	FLA (A)
PFFY-P20VCM-E	220-240V/50Hz 220-240V/60Hz	Max.: 264V Min.: 198V	0.59	0.096	0.47
PFFY-P25VCM-E			0.68	0.096	0.54
PFFY-P32VCM-E			0.78	0.096	0.62
PFFY-P40VCM-E			0.83	0.096	0.66
PFFY-P50VCM-E			1.05	0.096	0.84
PFFY-P63VCM-E			1.05	0.096	0.84

PFFY-P-VCM-E